

Using the LI-550 TriSonica® Mini Wind and Weather Sensor

LI-COR Environmental

4647 Superior Street
Lincoln, Nebraska 68504
Phone: +1-402-467-3576
Toll free: 800-447-3576 (U.S. & Canada)
envsales@licor.com
envsupport@licor.com
licor.com/env

LI-COR GmbH, Germany

Siemensstraße 25A
61352 Bad Homburg
Germany
Phone: +49 (0) 6172 17 17 771
envsales-gmbh@licor.com
envsupport-eu@licor.com

LI-COR Ltd., United Kingdom

St. John's Innovation Centre
Cowley Road
Cambridge
CB4 0WS
United Kingdom
Phone: +44 (0) 1223 422102
envsales-UK@licor.com
envsupport-eu@licor.com

Beijing LI-COR Bioscience Ltd.

Room 502-503, 5th Floor, Jimen No.1 Office Building
Xitucheng Road, Haidian District
Beijing, China
Phone: +86-400-1131-511
china-sales@licor.com
china-support@licor.com

LI-COR Distributor Network

licor.com/env/distributors

LI-COR®

Notice

The information in this document is subject to change without notice.

LI-COR MAKES NO WARRANTY OF ANY KIND WITH REGARD TO THIS MATERIAL, INCLUDING BUT NOT LIMITED TO THE IMPLIED WARRANTIES OF MERCHANTABILITY AND FITNESS FOR A PARTICULAR PURPOSE. LI-COR shall not be held liable for errors contained herein or for incidental or consequential damages in connection with the furnishing, performance, or use of this material.

This document contains proprietary information, which is protected by copyright. All rights are reserved. No part of this document may be photocopied, reproduced, or translated to another language without prior written consent of LI-COR, Inc.

The LI-550 and LI-560 sensors are protected by U.S. Patent Numbers 10,551,406, 11,268,974 and 11,543,427. The user may not copy or reverse engineer any physical, software, algorithm, or other component of the TriSonica device.

Windows® is a trademark of Microsoft, Inc. Gore-Tex® is a trademark of W.L. Gore & Associates. All other trademarks and registered trademarks are property of their respective owners. TriSonica is a registered trademark of LI-COR, Inc.

Printing History





© Copyright 2023, LI-COR, Inc. All rights reserved.

Publication Number: 984-20374

Created on Wednesday, December 13, 2023

Notes on Safety

This LI-COR product has been designed to be safe when operated in the manner described in this manual. The safety of this product cannot be assured if the product is used in any other way than is specified in this manual. The product is intended to be used by qualified personnel. Read this entire manual before using the product.

Equipment markings:	
	The product is marked with this symbol when it is necessary for you to refer to the manual or accompanying documents in order to protect against injury or damage to the product.
	The product is marked with this symbol when a hazardous voltage may be present.
	The product is marked with this symbol if a Chassis Ground connection is required.
	The product is marked with this symbol to indicate that a direct current (DC) power supply is required.
WARNING	Warnings must be followed carefully to avoid bodily injury.
CAUTION	Cautions must be observed to avoid damage to your equipment.
Manual markings:	
Warning	Warnings must be followed carefully to avoid bodily injury.
Caution	Cautions must be observed to avoid damage to your equipment.
Note	Notes contain important information and useful tips on the operation of your equipment.

CE Marking:

This product is a CE marked product. For conformity information, (typically EMC, Safety, RoHS, and/or Wireless) contact LI-COR Support at envsupport@licor.com for a Declaration of Conformity. Outside the U.S., contact your local sales office or distributor.

For ReaCH (Regulation (EC) n.1907/2006) related questions, information is available on the European Chemicals Agency maintained website for the Waste Framework Directive SCIP database.

You can search by product name (for this product “LI-550”), or request an “SCIP number” from the email above.

LI-COR scientific products are for professional use (non-consumer products). These products do not fall within the voluntary scopes of regulations: UNI EN ISO 14024, TCO Certified, EPEAT 2018, Blue Angel, TÜV Green Product Mark, Energy Star, EU GPP, or other similar regulations. The typical scope for these regulations is lighting, furniture, copiers, mobile phones, televisions, computer/servers, home appliances, to name a few. As such, our products do not use any labeling that indicates adherence thereof.

California Proposition 65 Warning

WARNING: This product contains chemicals known to the State of California to cause cancer and birth defects or other reproductive harm.

Federal Communications Commission Radio Interference Statement

WARNING: This equipment generates, uses, and can radiate radio frequency energy and if not installed in accordance with the instruction manual, may cause interference to radio communications. It has been tested and found to comply with the limits for a Class A computing device pursuant to Subpart J of Part 15 of FCC rules, which are designed to provide a reasonable protection against such interference when operated in a commercial environment. Operation of this equipment in a residential area is likely to cause interference in which case the user, at his own expense, will be required to take whatever measures may be required to correct the interference.

Waste Electronic and Electrical Equipment (WEEE) Notice

This symbol indicates that the product is to be collected separately from unsorted municipal waste. The following applies to users in European countries: This product is designated for separate collection at an appropriate collection point. Do not dispose of as household waste. For more information, contact your local distributor or the local authorities in charge of waste management.



WARNING: Protect the LI-550 from falling objects. Do not allow heavy objects to fall on the LI-550. If a LI-550 has experienced impact damage, do not touch the LI-550. Disconnect power before touching the sensor or inspecting for damage.

WARNING: For safety purposes, use batteries or a power supply certified with local standards; LI-COR is not responsible for any harm or safety issue caused by supplying the product with uncertified batteries, power supplies, or circuits.

WARNING: Do not attempt to open the enclosure. There are no user serviceable components. Do not touch a damaged sensor until after it has been disconnected from power. Do not apply power to a LI-550 sensor that has a damaged enclosure. If a LI-550 enclosure is damaged, disconnect power and stop using the device. Contact LI-COR or your distributor for assistance.

Contents

Section 1. Welcome to the TriSonica Mini

Introducing the LI-550F and the LI-550P	1-1
Accessories	1-2
USB interface adapter	1-2
LI-570 TriSonica Data Logger	1-2
Mounting adapters	1-2
Data and power cables	1-3
Software	1-3
TriSonica anemometer comparison	1-4

Section 2. Mounting options and considerations

Orientation	2-1
Mounting the LI-550F	2-2
User-supplied mount	2-2
550FM mounting adapter	2-3
Mounting the LI-550P	2-4
Pipe mount	2-4
550PM mounting adapter	2-5
Deployment considerations	2-6
Compass	2-6
Tilt and level	2-6
Environmental considerations	2-6
Humidity	2-6
Pressure	2-7
Ice and snow	2-7
Not submersible	2-7
Interference considerations	2-8
Other sonic anemometers	2-8
Compact fluorescent lamps	2-8
Wind tunnels and ultrasonic frequency	2-8
Electro-mechanical motors and magnetic sensors	2-8

Section 3. Connecting the power and data cable

LI-550F power and data	3-1
Power and data wire assignments	3-1
Connecting the LI-550F to the USB interface adapter	3-2

LI-550P power and data	3-3
Power and data wire assignments	3-3
Connecting the LI-550P to the USB interface adapter	3-5

Section 4. Communicating with the anemometer

Serial communication settings	4-1
Connecting with the TriSonica application	4-1
Connecting with a terminal emulator	4-3
Connecting to the LI-570 Data Logger	4-4
Configuration options	4-4
TriSonica Application graphical interface	4-4
Menu interface	4-4
Command-line interface	4-4
Serial data format	4-4
Parameters	4-5
Custom tags	4-6
Custom delimiters	4-6
Error codes	4-6

Section 5. Configuring with the menu interface

Main menu	5-1
Serial setup	5-2
Data output setup	5-2
Instrument setup	5-3
Calibration	5-3
Diagnostic	5-4
Instrument reset	5-4
Enter command line	5-4
Exit without storing changes	5-4
Exit	5-4

Section 6. Configuring with the command-line interface

Applying configuration changes	6-1
Restoring default settings	6-1
Basic mode commands	6-2
Expert mode commands	6-9
Application programming interface	6-14

Section 7. Troubleshooting

The sensor seems unresponsive	7-1
Connection issues, no serial data, or the connection fails	7-3
Unexpected readings or errors	7-5

Section 8. Calibration and maintenance

User calibration	8-1
Anemometer calibration	8-1
Level calibration	8-2
Compass calibration	8-2
Recovering from a bad calibration	8-2
Firmware updates	8-3
Updating firmware	8-3
Updating the bootloader	8-4
Cleaning the sensor	8-4

Section 9. Specifications

Appendix A. Lists of tables and figures

Standard Terms and Conditions

Index

Section 1.

Welcome to the TriSonica Mini

Welcome, and thank you for your purchase of the LI-550 TriSonica Mini Wind and Weather Sensor. The LI-550 is an ultrasonic anemometer that measures 3-dimensional wind speed and direction, as well as air temperature, humidity, and pressure. It features a built-in magnetometer and accelerometers to measure tilt, orientation, and movement. LI-550 bodies are injection molded of glass-reinforced nylon with carbon fiber posts. This instruction manual provides operating information for the flat-base (LI-550F) and pipe-mountable (LI-550P) models.

Introducing the LI-550F and the LI-550P

The LI-550F features a flat base with four mounting holes for M3 or 3/16" bolts. The LI-550P mounts on a hollow 1/2" schedule 10 pipe or 22-mm carbon fiber tube (set screws are tightened with 0.05 inch hex key). Mounting adapters are available to mount either model of LI-550 to a common tripod with 1/4-20 threads.



Figure 1-1. The LI-550F (left) features a flat base and four bare wires. The LI-550P (right) mounts to a pipe and features a 12-pin connector.

Accessories

A variety of accessories are available for TriSonica products.

USB interface adapter

Part number
550USB

USB interface adapter for the LI-550 and LI-560 sensors. Used to configure the devices and view data on a computer. Not for outdoor use.



LI-570 TriSonica Data Logger

Part number
LI-570

The LI-570 TriSonica Data Logger powers and logs data from up to four LI-550s, up to three LI-560s, or a combination of up to two LI-550s and two LI-560s. It features two 6-pin connectors to connect to 3rd party equipment (radio or GPS receiver), one 3-pin connector for power.

Mounting adapters

Mounting hardware is designed to simplify the installation of the LI-550s.

550FM flat base mounting adapter

Part number
550FM

The flat base mounting adapter is to mount the LI-550F to a camera tripod or other platform that uses 1/4-20 threads.



550PM pipe mounting adapter

Part number
550PM

The pipe mount adapter is to mount the LI-550P to a camera tripod or other platform that uses 1/4-20 threads.



Data and power cables

Several cables are available for power and transfer data from the device (see *Table 1-1* below).

Table 1-1. Cables available for the LI-550s and LI-560s.

Part Number	Description
571D-10	10-meter data and power cable with connectors at each end. Connects a LI-550P or LI-560 to the LI-570 Data Logger.
571D-1	1.25-meter data and power cable with connectors at each end. Connects a LI-550P or LI-560 sensor to the LI-570 Data Logger.
571S-1	1.25-meter data and power cable with connector at one end and blunt cut at the other.
571D-C	Two connector assemblies for a customer-built cable connecting a LI-550P or LI-560 sensor and the LI-570 Data Logger; 25-meter maximum length.

Software

A simple Windows®-compatible user-interface application is available for download from licor.com/env/support/LI-550/software.html.

Note: This application is not suitable for long-term data logging. It does not communicate with the LI-570 Data Logger at this time.

We recommend the use of a terminal emulator, such as Tera Term, to record data to a personal computer. The data stream from the anemometer also can be received, stored, and interpreted by an appropriate device of your choice, so long as it is connected to the anemometer by the proper communications protocol.

TriSonica anemometer comparison

The LI-550F and LI-550P TriSonica Mini and LI-560 TriSonica Sphere share many features, as shown in *Table 1-2* below. If you have a TriSonica Mini with a serial number below M00841, or an Anemoment product that is not described here, documentation for your product is available at licor.com/env/support/Anemometers/home.html.

Table 1-2. TriSonica family comparison guide.

Instrument	Mount	Connection	Protocols	Outputs	Measurements
LI-550F TriSonica Mini	Flat Base	4 Wires	EIA232	ASCII String	Wind Direction, Wind Velocity, Air Temperature, Air Pressure, Humidity, Tilt, Orientation
LI-550P TriSonica Mini	Pipe Mount	12-wire Connector	EIA232, EIA422, EIA485, LVTTTL-UART	ASCII String	Wind Direction, Wind Velocity, Air Temperature, Air Pressure, Humidity, Tilt, Orientation
LI-560 TriSonica Sphere	Pipe Mount	12-wire Connector	EIA232, EIA422, EIA485, LVTTTL-UART	ASCII String	Wind Direction, Wind Velocity, Air Temperature, Tilt

Section 2.

Mounting options and considerations

This section describes how to install the LI-550F and LI-550P and it covers considerations for deployment.

Orientation

The LI-550 has a north arrow indicator **N** on one of the upper arms. Airflow passing directly into the **N** will return zero degrees for wind direction regardless of the actual orientation of the sensor. Adjustments of wind direction for orientation other than pointing to true north can be done in post processing of data.

We do not recommend mounting the instrument in an upside-down position.

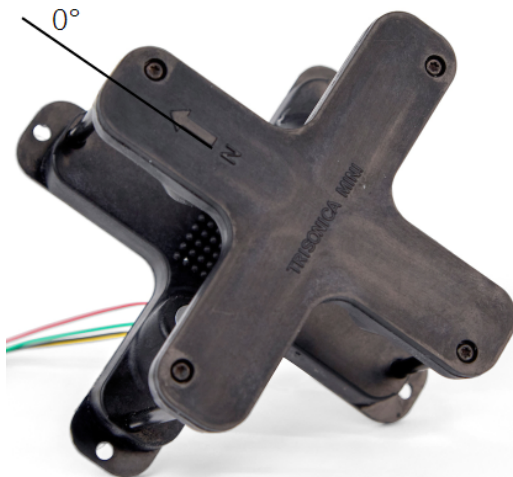

Figure 2-1. The north indicator is an arrow and letter N on the sensor.

Mounting the LI-550F

The LI-550F can be mounted directly to a user-supplied platform or with the 550FM mounting adapter.

User-supplied mount

The LI-550F features a flat base with four mounting points for connecting to a user-supplied mounting platform using four M3 or 3/16" bolts. The mounting platform should be flat with a 5-mm hole in the center for the connecting wires and 5.5-mm hole positioned at the Gore-Tex® vent to allow for water vapor and air pressure exchange.

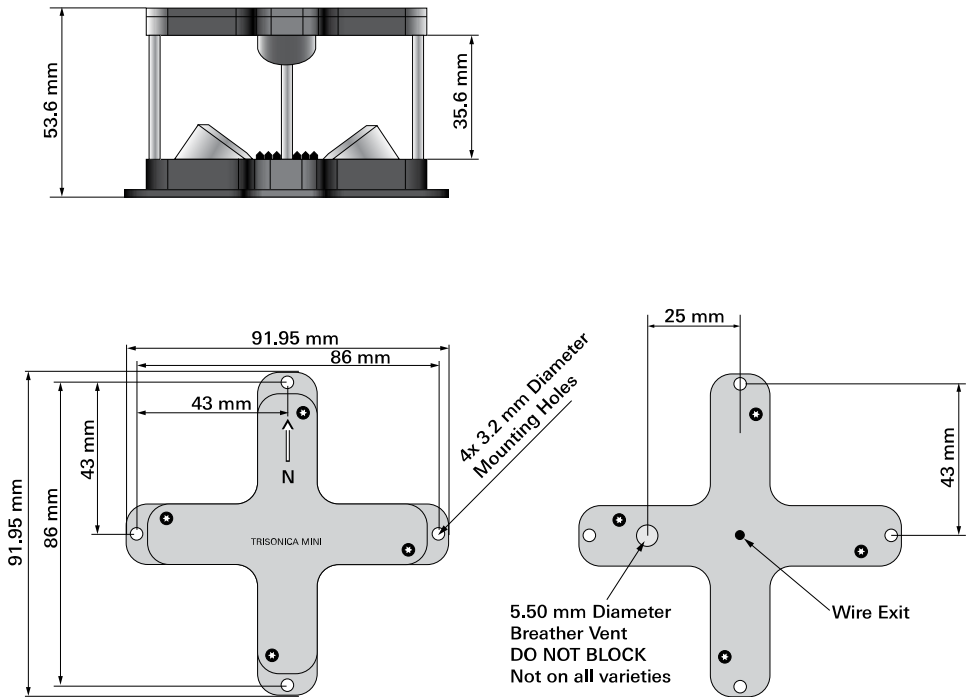

Figure 2-2. LI-550F dimensions.

550FM mounting adapter

The 550FM is an optional mounting adapter for attaching the LI-550F to a custom platform. It features a brass 1/4-20 threaded insert that is compatible with most camera tripods.

Note: Do not overtighten the mounting hardware. Doing so can damage the glass-filled Nylon anemometer body.

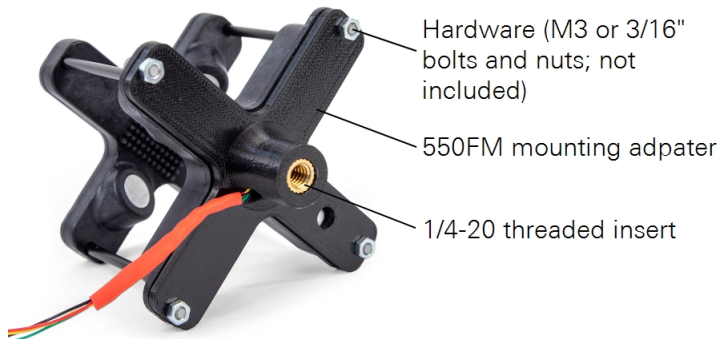

Figure 2-3. The LI-550F can be mounted with the mounting adapter.

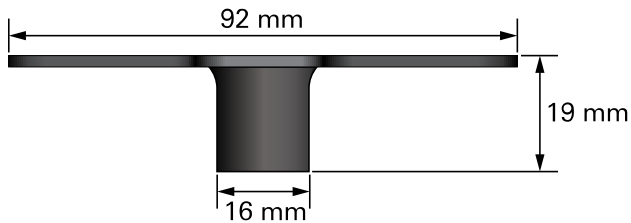

Figure 2-4. 550FM mounting adapter dimensions.

Mounting the LI-550P

The LI-550P can be mounted directly to pipe or with the 550PM mounting adapter.

Pipe mount

The LI-550P mounts to a 1/2 inch schedule 10 pipe (DN 15) or 22 mm carbon fiber tube. The pipe must have an inside diameter >17.1 mm to allow space for the cable. Set screws are tightened with a 0.05 inch hex key.

Before putting the LI-550P on the pipe, route the cable through the pipe. Then connect the cable to the base connector. Place the LI-550P over the pipe and tighten the set screws. For a detailed description of the internal wiring of the connector and cable see *Connecting the power and data cable* on page 3-1.

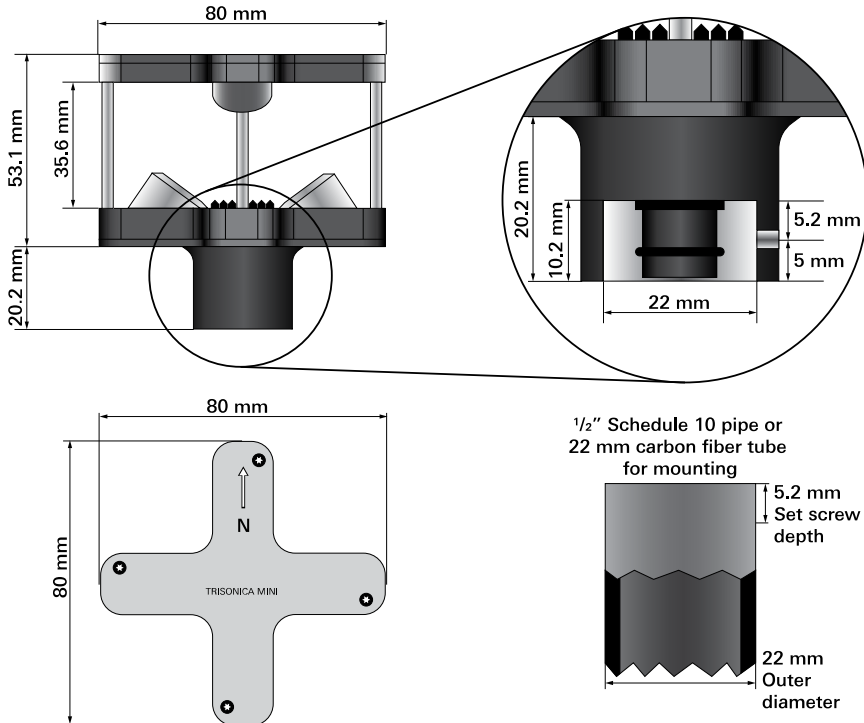

Figure 2-5. LI-550P dimensions.

550PM mounting adapter

The 550PM is an optional mounting adapter for attaching the LI-550P to a custom platform. It features a brass $\frac{1}{4}$ -20 threaded insert that is compatible with most camera tripods.



Figure 2-6. The LI-550P can be mounted with the mounting adapter.

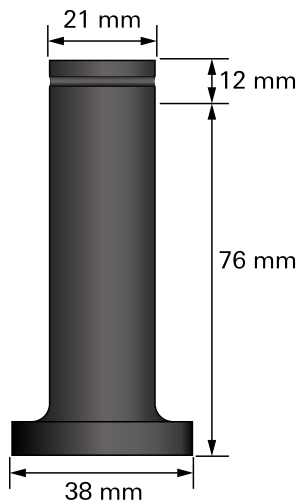

Figure 2-7. 550PM mounting adapter dimensions.

Deployment considerations

If you intend to use data from the compass or accelerometers, either with a single anemometer or to compare with other anemometers, these components should be calibrated in the environment where the device will be deployed.

Compass

A magnetic compass inside the LI-550 measures magnetic north. Since the reading of the compass is highly dependent on the magnetic environment around it, the compass is not calibrated during manufacturing. Instead, you should calibrate the compass in the environment where it will be used, especially if you want to combine data from multiple TriSonica sensors. Compass calibration can be initiated in the menu interface (see *Calibration* on page 5-3) or command-line interface (see *compasscalibrate* on page 6-3). See *Compass calibration* on page 8-2 for full details. The raw magnetometer outputs are also available.

Tilt and level

An accelerometer inside the LI-550 measures offsets from level. Because the mounting of the LI-550 affects the tilt, offsets are not set during manufacturing. Persistent offsets in the data could indicate that the calibration needs to be adjusted. Calibration can be initiated in the menu interface (see *Calibration* on page 5-3) or command-line interface (see *levelcalibrate* on page 6-5). See *Level calibration* on page 8-2 for more details. The raw accelerometer outputs are also available.

Environmental considerations

The LI-550 is designed for outdoor use¹, but some limitations apply. Protect the instrument from sustained rainfall and persistent high humidity (condensing conditions). If the device will sit outdoors unused for long periods, you can cover it to reduce the accumulation of dust, pollen, and other contaminants.

Humidity

The humidity sensor is located inside the LI-550 body. It measures water vapor that passes through the membrane (white Gore-Tex® dot). This causes a delay in the

¹The 550USB adapter is not for outdoor use, and must be protected from dust and wet conditions.

humidity reading when the humidity changes. This delay can be up to an hour for very large humidity changes, such as moving the unit from a 90% RH environment to a 30% RH environment. Normal environmental humidity changes that happen more slowly experience a shorter latency.

Humidity is determined by calculating the dew point inside the anemometer, assuming that the dew point is the same inside and out. The average of the ultrasonic temperature is used to calculate humidity from the dew point.

When an LI-550 is removed from a warm 90% humidity environment to a cooler 30% environment, the rapid change may cause condensation inside the unit, leading to a reported humidity greater than 100%. The reading will persist until the condensation has evaporated and equilibrated through the vent.

Pressure

The absolute pressure sensor is located inside the LI-550. The Gore-Tex® membrane ensures that air pressure inside the device is the same as ambient. A slight delay is noticed with rapid pressure changes.

Ice and snow

The small size and light weight that are the hallmark of the LI-550 leave no space for on-board heaters. If ice or snow accumulate within the LI-550, the acoustic pathways between transducers can be blocked. Although the dark coloring of the LI-550 facilitates natural solar removal of ice and snow, the LI-550 may not be the best choice of sensor for sustained use in wintery weather.

Not submersible

A VE9 series Gore-Tex® vent on the base of the LI-550 allows the internal humidity and air pressure sensors to measure ambient humidity and pressure. The internal mount vent protects the delicate electronics inside from water incursion.

Contact LI-COR if you have questions about the suitability of the LI-550 for your application.

Interference considerations

Be aware of these potential sources of interference as you plan your project.

Other sonic anemometers

If using more than one anemometer, maintain at least one meter separation distance between the two devices to prevent ultrasonic interference. Two anemometers that are close to each other may appear to work fine, but over time, the two clocks will come into phase with each other, leading to spikes in the measurements. Avoid the situation by maintaining at least one meter of separation.

Compact fluorescent lamps

Some compact florescent lamps (CFL) make ultrasonic noise that can interfere with the operation of a LI-550. Erroneous readings may result if the LI-550 is operated near compact florescent lamps. Turn off the CFL or move the sensor away from the CFL to reduce interference.

Wind tunnels and ultrasonic frequency

Ultrasonic anemometers operate by generating ultrasonic pulses and measuring the time of flight of those sound pulses between transducers. The time-of-flight measurements can be disturbed by external noise sources in or near the same frequency band used by the ultrasonic anemometer's transducers. The LI-550 operates in the 60 KHz ultrasonic frequency range.

We have found that some wind tunnels generate ultrasonic noise that can cause erroneous readings. This is not an indication of failure of the anemometer but is a result of using the anemometer in an ultrasonically noisy environment.

Electro-mechanical motors and magnetic sensors

Electro-mechanical motors generate magnetic fields; the effect of the field on a magnetic sensor varies by distance of the sensor to the motor and by the speed (and variations of speed) at which the motor is operated. The magnetic sensor aboard the LI-550 will be affected by the field generated by ferrous materials and motors nearby. The LI-550 should be placed in a position outside the effects of these fields. We recommend that you consider the effects of magnetic fields arising from your unique configuration in both your hardware and software design.

Section 3.

Connecting the power and data cable

This section describes how to power up the LI-550, connect data cables, configure it, and get data from it.

LI-550F power and data

The LI-550F features a four-wire cable for power and data. The cable can be attached to a data logger or USB adapter.

Power and data wire assignments

Four unterminated wires exit the base of the LI-550F. The wires are color coded to indicate the purpose of each.

Table 3-1. Wire assignments for the LI-550F.

Color	Description
Yellow	Power in; +5 to 30 VDC
Green	RS-232 RX+; serial data receive
Red	RS-232 TX+; serial data transmit
Black	Ground and serial data return

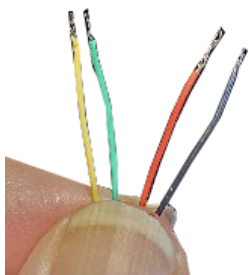

Early models of the TriSonica Mini may have different color wires or additional wires. Refer to instructions accompanying the specially configured sensor for more information.

Connecting the LI-550F to the USB interface adapter

Use a USB-C cable (not included) to connect the adapter to your computer.

Note: The USB adapter is for scientific research and development use only. Do not use the USB adapter in wet locations.

Open the USB adapter case and connect the wires from the LI-550F to the terminal block. Then connect the adapter to a computer using a USB cable.

Table 3-2. LI-550F-to-USB adapter wire colors and assignments.

Color	Description (LI-550F)	USB adapter connection
Yellow	Power in; +5 to 30 VDC	12 V power out
Green	RS-232 RX+; serial data receive	TX+; serial data transmit
Red	RS-232 TX+; serial data transmit	RX+; serial data receive
Black	Ground and serial data return	Ground; data and power



A video demonstrating this connection is available at licor.com/env/support/LI-550/videos.html.

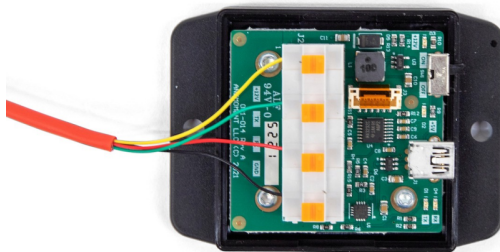
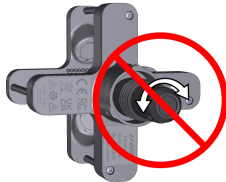

Figure 3-1. USB adapter with the top cover removed. Wire colors represent the LI-550F.

LI-550P power and data

The LI-550P features a 12-pin circular connector. When connected properly, the connector should provide good protection against water ingress. Additional protection can be provided by the mounting configuration.

Important: Do not twist the cable during installation or removal. Doing so will damage the connector pins. To remove the cable, grasp the collar and pull it away from the anemometer.



DO NOT TWIST the cable. Doing so will break the pins.

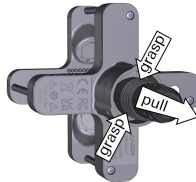

Grasp the collar and pull to disconnect.

Pre-made cables with connectors may be purchased from LI-COR in 1.25 and 10 meter lengths. Customized cables and can be made with the custom cable kit. Because this detachable cord carries both data and power, replacement cords or user-built cords must comply with the wiring and insulation specifications set out in the EIA Standard appropriate for the selected communication protocol.

Power and data wire assignments

Figure 3-2 below shows the socket assignments for the connector on the LI-550P. The internal wire colors and descriptions are given in Table 3-4 on page 3-5.

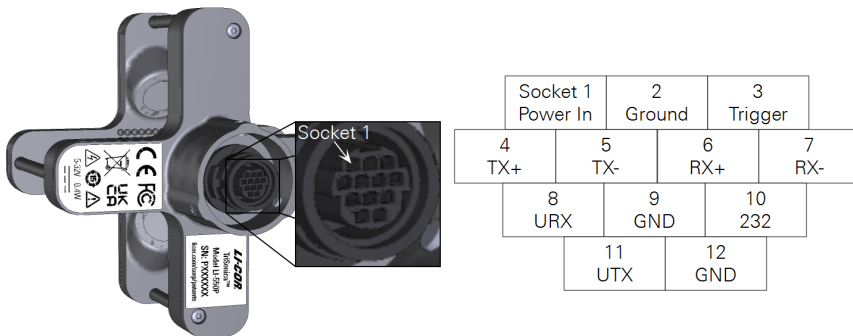

Figure 3-2. 12-socket connector and assignments on the LI-550P.

Caution: The Power In wire is the only one that can handle voltages exceeding five volts. Applying excess voltage to other wires can damage the LI-550. Such damage is not covered by the warranty.

Table 3-3. LI-550P socket descriptions and cable wire colors.

Socket	Color	Description
1	Brown	Power In: 5 to 32 VDC.
2	Red	Ground connection. Only one GND connection is required for proper operation. Multiple GND connections are provided for convenience.
3	Orange	Synchronizing trigger input. This input allows multiple instruments to synchronize sampling to a common signal.
4	Yellow	Serial transmit data output in EIA232 mode and TX+ data output in EIA422 mode.
5	Green	Serial transmit data output TX- in EIA422 mode. Not used in EIA232 mode.
6	Blue	Serial receive data input in EIA232 mode and RX+ data output in EIA422 mode.
7	Violet	Serial receive data input RX- in EIA422 mode. Not used in EIA232 mode.
8	Gray	URX; 3.3V LVTTTL UART serial data input.
9	White	Ground connection.
10	Black	232; Force single ended serial mode. When connected to GND, the LI-550 will start in EIA232 or LVTTTL-UART mode with the settings of 115200,8,N,1 regardless of the software settings of the instrument.
11	Light Green	UTX; 3.3V LVTTTL-UART serial data output.
12	Pink	Ground connection.

Connecting the LI-550P to the USB interface adapter

Note: The USB adapter is for scientific research and development use only. Do not use the USB adapter in wet locations.

The single-terminated blunt-cut cable is to connect the LI-550P to the USB adapter. Separate the brown, blue, yellow, red, and black wires from the bundle and strip 3 mm of insulation from the ends of each wire. Open the adapter case and connect wires to the terminal block as shown in *Figure 3-3* below.

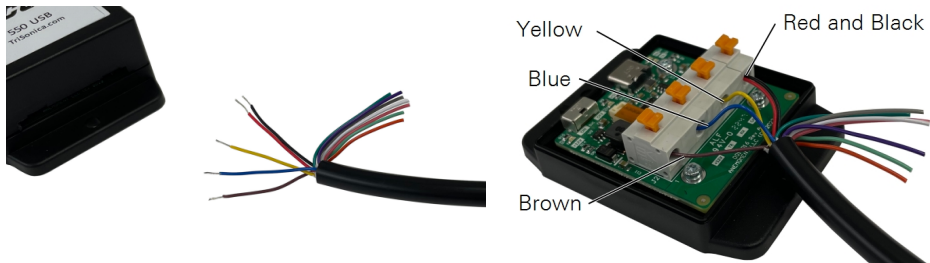

Figure 3-3. Separate the wire leads from the cable and connect to the USB adapter.

Table 3-4. LI-550P-to-USB adapter wire colors and assignments.

Color	Description (LI-550P)	USB adapter connection
Brown	Power in; +5 to 30 VDC	12 V power out
Blue	RS-232 TX+; serial data transmit	RX+; serial data receive
Yellow	RS-232 RX+; serial data receive	TX+; serial data transmit
Red and Black	Ground and serial return	Ground; data and power

Note: The cable contains 12 wires to accommodate the multi-protocol capable LI-550P. Some wires are not used in this application.



A video demonstrating this connection is available at licor.com/env/support/LI-550/videos.html.

Section 4.

Communicating with the anemometer

This section explains how to connect and what to expect after connecting.

Serial communication settings

The LI-550 starts generating data about one second after power up, and outputs data continuously when in sampling mode. With the LI-550 connected to a computer using the USB adapter or similar device that supplies power to the LI-550 and allows data to pass through, data can be viewed with the TriSonica application or a terminal emulator.

- Baud Rate: 115,200
- Data Bits: 8
- Parity: None
- Stop Bits: 1

Connecting with the TriSonica application

To connect using the TriSonica application:

- 1** Connect the data and power cables and power on the anemometer.
See *Connecting the power and data cable* on page 3-1.
- 2** Launch the TriSonica application.
Download from licor.com/env/support/LI-550/software.html.
- 3** Select the serial port that is used for the USB-to-serial adapter.

All active ports will be presented in the drop-down list (you can use a Serial Port Identifier application or find it in your computer's Device Manager). In the example, it is COM3. The software will attempt to connect immediately after selecting the port.

Port not listed? See *Connection issues, no serial data, or the connection fails* on page 7-3 for troubleshooting.

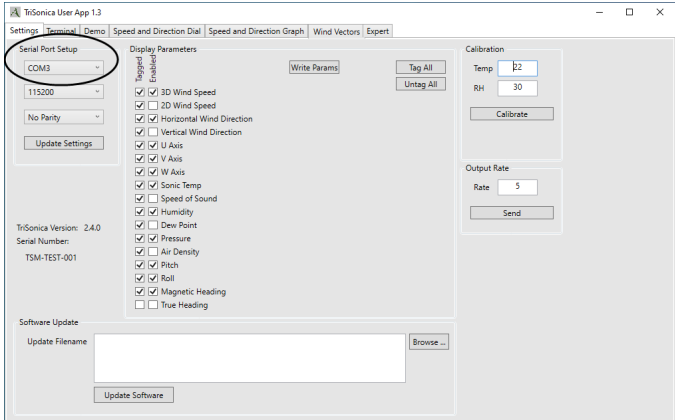

When connected, you'll see data as it is written to the **Terminal** tab. If display parameters have been set, you can view plots under the other tabs as well: **Demo**, **Speed and Direction Dial**, **Speed and Direction Graphs**, **Speed and Direction Graphs**, and **Wind Vectors**.

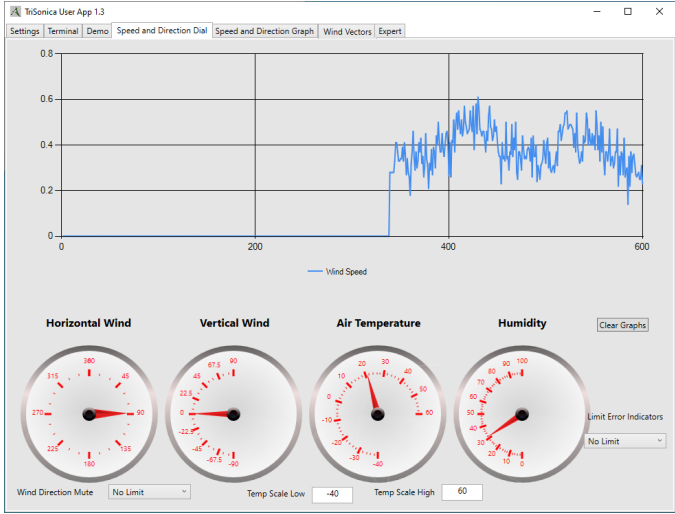

Connection error or no data? See *Troubleshooting* on page 7-1 for help connecting.

Note: This software application is not suitable for data logging functions.

Connecting with a terminal emulator

To connect using Tera Term:

- 1 Connect the data and power cables and power on the anemometer.
See *Connecting the power and data cable* on page 3-1.
- 2 In Tera Term, start a **New connection**, select **Serial** as the connection type, select the **Port** used by the USB-to-serial adapter, and click **OK**.
Port not listed? See *Connection issues, no serial data, or the connection fails* on page 7-3 for troubleshooting.

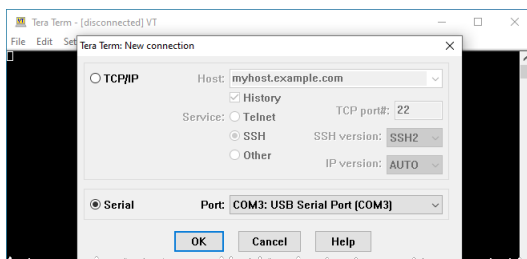

If the default baud rate of the terminal is incorrect, data will appear as non alphanumeric characters. To resolve the issue, change the serial port baud rate to 115200 under **Setup > Serial port**.

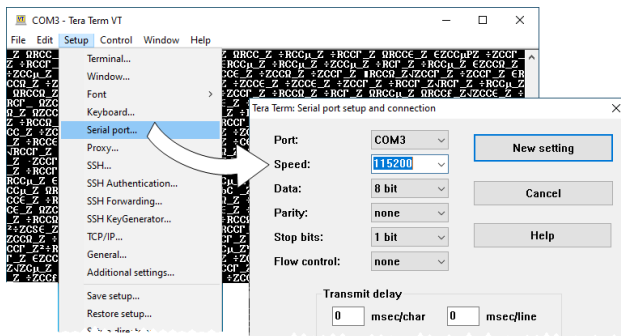

- 3 Data will be presented in the Terminal interface.

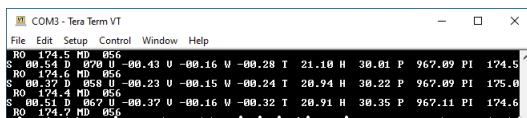

Connection error or no data? See *Troubleshooting* on page 7-1 for help connecting.

Connecting to the LI-570 Data Logger

When the TriSonica is connected to the LI-570 Data Logger, communication is mediated by the logger. The interface includes a detailed **help** menu and full instructions are available at licor.com/TriSonica-support.

Configuration options

After connecting with either the TriSonica application or a terminal program, you can configure the anemometer in three ways:

TriSonica Application graphical interface

In the TriSonica application, some options are available in the **Settings** tab (see *Connecting with the TriSonica application* on page 4-1).

Menu interface

In a terminal program or the TriSonica application **Terminal** tab, press **ESC** to view the menu (see *Configuring with the menu interface* on page 5-1).

- Press **X** to discard changes and return to sampling mode.
- Press **0** (zero) to store changes and return to sampling mode.

Command-line interface

In a terminal program or the TriSonica application **Terminal** tab, press **Ctrl + C** to enter the command-line interface (see *Configuring with the command-line interface* on page 6-1).

- Type **help** to view the command-line help menu.
- Type **exit** to return to sampling mode.

Serial data format

The LI-550 outputs data in an ASCII character string ending with carriage return and line feed characters. Each line is a single record of all the measured parameters contained in a single sample.

Note: Although you can configure which measurements appear in the data string, the order in which the measurement data appears is not customizable.

The parameters on an output line are separated by two spaces or by a single space and a negative sign. You can use custom data tags to indicate the measurement associated with the value; the tags can be turned on or off for each individual type measurement. These options are described in *Basic mode commands* on page 6-2.

Parameters

The variables measured by the LI-550, default units, and default tags are listed in *Table 4-1* below. Units and tags are user-configurable (see *Data output setup* on page 5-2).

Table 4-1. Variables measured by the LI-550, as well as default tags and units. Tags are user-configurable and units are user-selectable.

Variable	Default Tag	Default Units	Optional Units
Wind Speed	S	m/s	mps, kph, mph, fps, or kts
2D Wind Speed	S2	m/s	mps, kph, mph, fps, or kts
Horizontal Wind Direction	D	degrees	
Vertical Wind Direction	DV	degrees	
U Vector	U		
V Vector	V		
W Vector	W		
Speed of Sound	C		
Temperature	T	°C	°F
Relative Humidity	H	%	
Dew Point	DP	°C	°F
Absolute Pressure	P	hPa	kPa, hPa, Pa, bar, mbar, psi, atm
Air Density	AD	kg/m ³	lb/ft ³
Accelerometer X	AX		
Accelerometer Y	AY		
Accelerometer Z	AZ		
Pitch Angle	PI	degrees	
Roll Angle	RO	degrees	
Magnetometer X	MX		
Magnetometer Y	MY		
Magnetometer Z	MZ		
Magnetic Heading Angle	MD	degrees	
True Heading	TD	degrees	

Custom tags

Listing 4-1 below gives an example of a data stream without tags. In this example, the columns are wind speed, wind direction, U vector, V vector, W vector, and temperature.

Listing 4-1. A sample of the output without tags.

```
05.2 112 -01.9 04.7 01.1 22.6
05.3 107 -01.5 04.9 01.3 22.2
```

Listing 4-2 below gives an example of a data stream with tags. The data labels are **S** = wind speed; **D** = wind direction; **U** = U-vector; **V** = V-vector; **W** = W-vector; **T** = temperature.

Listing 4-2. A sample of the output data with tags.

```
S 05.2 D 112 U -01.9 V 04.7 W 01.1 T 22.6
S 05.3 D 107 U -01.5 V 04.9 W 01.3 T 22.2
```

Custom delimiters

The delimiters for the tags and parameters are customizable. In this example, a colon is used after the tags in place of the space and a comma is added after the measurement value. The default delimiters for both the tag and parameter name are a space character. Details on how to use this feature are given with the `paramdelim` and `tagdelim` commands.

Listing 4-3. Example of custom delimiters.

```
S:05.2,D:112,U:-01.9,V:04.7,W:01.1,T:22.6
S:05.3,D:107,U:-01.5,V:04.9,W:01.3,T:22.2
```

Error codes

When the anemometer firmware detects an error, it outputs an error code in the data stream in all the affected parameters. All error codes appear as `-99.xx`. The decimal value of the error code varies with the error type.

See *Troubleshooting* on page 7-1 for help with error codes.

Section 5.

Configuring with the menu interface

This section describes how to communicate with the LI-550, define which variables appear, how variables are labeled, and how often data packets arrive. The serial connection (see *Communicating with the anemometer* on page 4-1) allows you to interact with the anemometer in several ways. The choice of method is largely up to you, though some advanced settings are only available through expert mode of the command-line interface. The options are:

- *Main menu* below.
- *Configuring with the command-line interface* on page 6-1.
- *Application programming interface* on page 6-14.

Main menu

After connecting (see *Communicating with the anemometer* on page 4-1) and entering a terminal display, press `ESC` to bring up the Main Menu.

```
Main Menu:
A. Serial Setup
B. Data Output Setup
C. Instrument Setup
D. Calibration
E. Diagnostic
G. Instrument Reset
W. Enter Command Line
X. Exit Without Storing Changes
0. Exit
Choice: █
```

Note: Not all settings are accessible from this menu (see *Configuring with the command-line interface* on page 6-1).

If no input is received for one minute, the sensor returns to sampling mode and *changes are not stored in the non-volatile memory*. Press a key to stay in menu mode, or ESC again to re-enter menu mode.

Serial setup

From the main menu, press **A** to enter the serial setup menu where you can configure the baud rate, parity, and serial protocol (LI-550P only).

```

Serial Menu:
Changes apply after exiting the main menu.
A. Baud Rate .. < 115200 >
B. Parity ..... < None >
C. Protocol ... < EIA232 >
0. Return to Main Menu
Choice: █
    
```

Menu Option	Description
Baud Rate	Press A to toggle between the available baud rates.
Parity	Press B to toggle the parity settings.
Protocol	Press C to toggle the serial protocol settings (LI-550P only).

Data output setup

From the main menu, press **B** for a list of output parameters, indicating whether they are enabled, how many decimals are displayed, the units for the parameters, and the data tag. See *Table 4-1* on page 4-5 for a list of parameters available from the LI-550.

```

Output Menu:
A. Wind Speed ..... < Enabled : 2 Decimals : Units m/s : Tag On : S >
B. 2D Wind Speed .. < Enabled : 2 Decimals : Units m/s : Tag On : S2 >
C. Horizontal Wind Dir < Enabled : 0 Decimals : Units Degrees : Tag On : D >
D. Vertical Wind Dir .. < Enabled : 0 Decimals : Units Degrees : Tag On : DU >
E. U Vector ..... < Enabled : 2 Decimals : Units m/s : Tag On : U >
F. V Vector ..... < Enabled : 2 Decimals : Units m/s : Tag On : U >
G. W Vector ..... < Enabled : 2 Decimals : Units m/s : Tag On : W >
H. Speed of Sound ..... < Enabled : 2 Decimals : Units m/s : Tag On : C >
I. Temperature ..... < Enabled : 2 Decimals : Units C : Tag On : T >
J. Relative Humidity ... < Enabled : 2 Decimals : Units % : Tag On : H >
K. Dew Point ..... < Enabled : 2 Decimals : Units C : Tag On : DP >
L. Absolute Pressure ... < Enabled : 2 Decimals : Units hPa : Tag On : P >
M. Air Density ..... < Enabled : 2 Decimals : Units kg/m3 : Tag On : D >
    
```

From this menu, press the letter key to access submenus that control the parameter. Most menus present options that can be toggled by pressing the corresponding letter key.

```

Parameter Menu:
A. Enabled ... (* )
B. Tagged ... (* )
C. Tag ..... ( S )
D. Decimals .. ( 2 )
Ø. Return to Output Menu
Choice: █

```

Instrument setup

From the main menu, press **C** to set the data output rate, orientation, and trigger parameters (LI-550P only).

```

Instrument Menu:
A. Data Output Rate <Hz> ..... ( 5.0000 )
C. OrientUV ..... ( STD: U+ W->E, U+ S->N, W+ Up )
D. Trigger ..... ( Internal )
Ø. Return to Main Menu
Choice: █

```

Menu Option	Description
Data Output Rate (Hz)	Opens a menu to set the output rate. Options include 10 Hz, 5 Hz, 2 Hz, 1 Hz, 2 seconds, 5 seconds, and 10 seconds.
OrientUV	Toggles between standard, OTSM, and ATI. See <i>orientuv</i> on page 6-11.
Trigger	Toggles between internal, external, and synchronizing.

Calibration

From the main menu, press **D** to start calibration of wind, level, and compass.

```

Calibrate Menu:
A. Wind Sensor
B. Level
C. Compass
D. Calibration Certificate
Ø. Return to Main Menu
Choice: █

```

Menu Option	Description
Wind Sensor	Calibrates wind measurements. See <i>Anemometer calibration</i> on page 8-1.
Level	Calibrates the level. See <i>Level calibration</i> on page 8-2.
Calibration Certificate	Displays the factory calibration information.
Compass	Calibrates the compass. See <i>Compass calibration</i> on page 8-2.

Diagnostic

From the main menu, press **E** to run built-in diagnostics and display the results. If everything is as expected, the device responds with `No Problems Found`. If issues are detected, the device will deliver a more specific message with guidance to solve the problem (e.g., `Check for blockage on Transducer 1`).

Instrument reset

From the main menu, press **G** to reset the instrument, which will clear all volatile memory and restore all settings to the previously saved settings.

Enter command line

From the main menu, press **W** to enter the command-line mode. Previous changes are not saved when you enter command-line mode. See *Configuring with the command-line interface* on page 6-1 for details.

Exit without storing changes

From the main menu, press **X** to apply the changes temporarily and exit the menu. Changes made up to this point *are not* stored in the non-volatile memory and will be lost after the instrument is restarted.

Exit

From the main menu, press **0** (zero) to *exit the menu and store changes* in non-volatile memory. Changes made up to this point *are* retained even after a system reset or restart.

Section 6.

Configuring with the command-line interface

The command-line interface is a simple way to access all of the functions available in the anemometer, starting with important information about how you save changes to the anemometer configuration.

Applying configuration changes

Each time the LI-550 is powered up, it gets a copy of configuration parameters from non-volatile memory (Flash) and places it in temporary volatile memory (RAM) for operational access.

When you make changes to parameters using the serial menu or command-line, the changed parameters are updated in the temporary volatile memory, but they are not updated in the non-volatile memory. This means these changes are lost when the unit restarts, because the LI-550 replaces the parameters in the volatile memory with a fresh copy of the parameters saved in the non-volatile memory.

If you do not want the changes to be lost, copy the parameter changes saved in volatile memory to the non-volatile memory using the `nvwrite` command. The changes will then be remembered during a restart.

Restoring default settings

If, after making changes to non-volatile memory, you want to restore the permanently saved parameters to their original default values, this can be done by using the command `factoryrestore YES` in the expert menu mode.

Basic mode commands

After connecting with either a terminal program or the TriSonica application (select the Terminal tab), press `Ctrl + C` to enter command-line interface (CLI) mode. The LI-550 will stop sampling and provide a prompt: `>`. If no input is given within one minute, the LI-550 returns to sampling mode and changes are not saved in non-volatile memory.

Details of all available commands and their parameters are accessed within the command-line interface by typing `help` at the prompt.

Note: The LI-550 command-line interface is self-documented. The detailed help for each command may differ from what appears in the following sections. You can download the current firmware release notes at licor.com/env/support/LI-550/software.html.

help

Displays a list of command-line interface commands. The command `help` followed by the name of another command displays detailed help for that command (e.g., `help baudrate`)

Table 6-1. The `help` command.

Command	Description
<code>help</code>	Displays commands available in the command-line interface.
<code>command</code>	e.g., <code>help baudrate</code> , <code>help declination</code> , and so on.

exit

Type `exit` to leave the command-line interface and return to sampling mode.

Command	Description
<code>exit</code>	Leaves the command-line interface and returns to sampling mode.

baudrate

Shows or sets the current baud rate. Type the word `baudrate` followed by the desired rate (must be a valid baud rate of 9600, 19200, 38400, 57600, 115200, 230400) and press return. Add the word `now` to change the baud rate immediately.

Otherwise, the baud rate is placed in memory to be written to non-volatile memory using the `nvwrite` command and used on the next reset.

Note: In order for the LI-550 or LI-560 to communicate with the terminal program, the baud rate (and parity) for both needs to match. Changing the baud rate (or the parity) in the anemometer memory (whether volatile or non-volatile) does not change the baud rate (or parity) in the terminal program. If you choose to change the baud rate (or parity) in the LI-550 or LI-560, be sure to make a matching change in the Terminal Program's settings.

calibrate

To calibrate the precise length of the acoustic path between pairs of transducers. This length is a defining component in the detection and calculation of wind speed and direction. Actual air temperature, relative humidity, and absolute pressure variables are included in the calculation of the acoustic path length. The subcommands allow you to input specific values for each variable. Absolute pressure is an insignificant variable in this calculation, but you can make this entry if required under a specific test protocol.

You can calibrate the LI-550 to local conditions or test conditions using the `calibrate` command by following steps in *User calibration* on page 8-1.

Command	Description
<code>calibrate</code>	When sent with a parameter, initiates the calibration.
<code>temp</code>	Temperature in Celsius inside the calibration chamber.
<code>rh</code>	Relative humidity percent inside the calibration chamber.
<code>p</code>	Absolute pressure in hPa (millibars).

If relative humidity and pressure are omitted, the internal humidity and pressure sensors are used if their values are available. Otherwise, an relative humidity value of 50% is used for humidity and 1013.25 hPa is used as the absolute pressure value.

compasscalibrate

Type `compasscalibrate yes` to initiate the compass calibration. This command runs for 10 second. During that time rotate and tilt the anemometer in as many different orientations as possible, being sure to have rotated the unit fully in the X, Y, and Z directions. See *Compass calibration* on page 8-2 for more details.

decimals

Set the number of decimal places of a display parameter or a group of parameters. Enter `decimals` to view a list of the current settings and parameters that can be changed. Enter `decimals` followed by the `parameter` and the number of digits after the decimal. You can use the name of a single parameter or a group as listed by the `decimals` or `display` command. The `parameter` is case sensitive. For example, to set wind speed to three decimals, send `decimals S 3`.

declination

Type `declination` to view the current declination offset in degrees clockwise from magnetic north. To set the declination to 6°, for example, enter `declination 6` and press return.

diagnostic

Type `diagnostic` to for a report on problems found with the anemometer. Type `diagnostic details` for a more detailed diagnostic output. Enter `diagnostic clear` to clear the error counts displayed in the details parameter.

display

The `display` command shows a table indicating the name and description of each parameter available, whether it is tagged or not, what the tag value is, number of decimals displayed, whether the signal is enabled to be added to the serial output string, and the units for each measurement. See *Table 4-1* on page 4-5 for a full list of parameters, tags, and units.

```
> display
Display Value List:
```

Name	Description	Tagged	Tag	Decimals	Enabled	Units
S	Wind Speed 3D		S	1	Yes	m/s
S2D	Wind Speed 2D		S2D	1		m/s
D	Horiz Wind Direction		D		Yes	Degrees
DU	Vert Wind Direction		DU			Degrees
U	U Vector		U	1	Yes	m/s
U	U Vector		U	1	Yes	m/s
W	W Vector		W	1	Yes	m/s
T	Temperature		T		Yes	C
Cs	Speed of Sound		C	1		m/s

Figure 6-1. The `display` command retrieves the current configuration - showing parameters that are available, tag status, tag value, number of decimals, whether enabled, and the units.

expert

Type `expert enable` to access advanced menus, as described in *Expert mode commands* on page 6-9. Type `expert disable` to return to normal mode.

hide

Similar to the `show`, `tag`, `untag`, and `decimals` commands, the `hide` command is to view a list of display parameters or groups available to be hidden. It also provides a list of all values currently being displayed. When used with a parameter, the `hide` command removes that parameter from the list of displayed variables.

The `parameter` can be the name of a single parameter or a group as listed by the `show` or `display` command. The `parameter` is case sensitive.

- **Example:** `hide IDTag`
- **Reply:** None; removes the IDTag from the data stream.

levelcalibrate

To calibrate the level while on a known level surface. Place the anemometer upright on a level horizontal surface. Enter `levelcalibrate YES` to execute the command. Do not disturb the unit during calibration. If the device detects that it is too far from level, it will automatically cancel the calibration. See *Level calibration* on page 8-2 for more details.

nvwrite

Writes parameter data to non-volatile memory. Writes to flash memory to preserve the configuration during power down. See *Applying configuration changes* on page 6-1 for more details.

outputrate

Type `outputrate` to view the current setting. Enter `outputrate` followed by the desired rate to set the parameter. For example `outputrate 5` will set the rate to 5 Hz.

parity

Show or set the current parity setting. Parity can be applied immediately or written to flash for the next reset. Options include odd, even, and none. Append the

command with `now` to apply the change immediately. Otherwise, the setting is placed in memory to be written to non-volatile memory using the `nvwrite` command and used on the next reset.

Note: In order for the LI-550 or LI-560 to communicate with the terminal program, the baud rate (and parity) for both needs to match. Changing the baud rate (or the parity) in the anemometer memory (whether volatile or non-volatile) does not change the baud rate (or parity) in the terminal program. If you choose to change the baud rate (or parity) in the LI-550 or LI-560, be sure to make a matching change in the Terminal Program's settings.

programupdate

Puts the TriSonica into update mode. In update mode, you can update the program, using a serial terminal emulation program such as Tera Term, using the YModem protocol. See *Firmware updates* on page 8-3.

show

Similar to the `hide`, `tag`, `untag`, and `decimals` commands, the `show` command is to view a list of display parameters or groups available to be shown. When used with a parameter, the `show` command adds that parameter to the list of displayed variables. The `parameter` can be the name of a single parameter or a group as listed by the `show` or `display` command. The `parameter` is case sensitive.

- **Example:** `show IDTag`
- **Reply:** None; adds the IDTag to the data stream.

systemreset

Enter `systemreset` followed by return to immediately reset the device.

tag

Similar to the `hide`, `show`, `untag`, and `decimals` commands, the `tag` command is to view and set the ID tags applied to a parameter or group of parameters. When used with a parameter, the `tag` command adds that parameter to the list of displayed variables. The `parameter` can be the name of a single parameter or a group as listed by the `show` or `display` command. The `parameter` is case sensitive.

triggertype

Set or get the sampling trigger type (not available on LI-550F or TSM-WS).

trisonicaid

Enter `trisonicaid` to view the current ID setting. Enter `trisonicaid 001` to set the ID to 001, for example. Enter `trisonicaid clear` to remove the ID. The `trisonicaid` may be up to 40 characters in length to accommodate a UUID.

units

The command sets or displays the units value for all adjustable parameters. Enter `units` to view the units for measurements. See *Table 4-1* on page 4-5 for a full list of parameters and the units available.

```
Unit Output for a Signal
-----
Available Individual Parameters
-----
```

Name	Description	Units
S	Wind Speed 3D	m/s
S2D	Wind Speed 2D	m/s
U	U Vector	m/s
V	V Vector	m/s
W	W Vector	m/s
T	Temperature	C
Cs	Speed of Sound	m/s
RHTemp	RH Temp Sensor	C
DP	DewPoint	C
PTemp	Pressure Temp Sensor	C
P	Pressure Sensor	hPa
Density	Air Density	kg/m^3
CTemp	Compass Temp	C

```
>
```

Figure 6-2. The `units` menu displays variable names, descriptions, and the units that are currently in use.

To change units for a parameter, enter `units` followed by the name (see *Figure 6-2* above), followed by the new units.

- **Example:** `units P kPa` will set pressure units to kPa.
- **Reply:** None.

Units can be set for a single parameter or a family of units.

- **Example:** `units si` will apply international (si) units to all parameters.
- **Reply:** None.

Command	Description
units	Displays and configures the units
si	Set all parameters to default metric units (m/s, C, hPa, kg/m^3)
sae	Set all parameters to the sae units (mph, F, psi, lb/ft^3)
velocity	Units for velocity (mps, kph, mph, fps, or kts)
temperature	Units for temperature (C and F)
pressure	Units for pressure (kPa, hPa, Pa, Bar, mBar, psi, atm)
density	Options for density are si and sae

untag

Similar to the `hide`, `show`, `untag`, and `decimals` commands, the `untag` command is to view a list of display parameters or groups that can be untagged. Enter `untag` to view a list of all available parameters that can have the tag removed from the display output. Enter `untag` followed by a parameter to remove the tag from a display parameter or a group of parameters.

The `parameter` can be the name of a single parameter or a group as listed by the `show` or `display` command. The `parameter` is case sensitive.

version

Type `version` to see the firmware version, serial number, and other details.

```
> version
Anemoment LLC
TriSonica Mini Weather Station Multi-Protocol - Ultrasonic Anemometer
Serial Number: TSM-TEST-001
Version: 2.4.0
Humidity Sensor - Present
Pressure Sensor - Present
Accelerometer - Present
Compass - Present
> █
```

wd540

Type `wd540` to view the current settings. Type `wd540 enable` to apply the 540° mode; Type `wd540 disable` to return to normal 0 - 360° mode.

The LI-550 default horizontal wind direction parameter reports wind direction as 0 to 360 degrees. If you want to display horizontal wind direction data on a time-series graph, horizontal wind that is approaching the anemometer from near north (0/360) appear as large directional changes rather than gradual changes.

To avoid this display issue, apply the wind direction scale command (`wd540`) parameter. This prevents the graph from showing large directional shifts when crossing 359° to 0°. When the `wd540` parameter is applied, the firmware recognizes two representations of 360 degrees: a 0-to-360-mode, and a 180-to-540-mode. The anemometer begins in the 0-to-360-mode. When the wind direction crosses 360 or 0 degrees, the firmware shifts to 180-to-540 mode. The anemometer stays in the 180-to-540 mode until the wind direction again crosses either 180 or 540, which causes the anemometer to return to 0-to-360-mode.

Expert mode commands

When expert mode is enabled (from the command-line, type `expert enable`), additional commands are present in the help menu. These commands enable more advanced settings and configurations that may be outside of the normal operating settings. We recommend that you understand the effects of these commands before use. Changes made in expert mode are stored as described in *Applying configuration changes* on page 6-1

averagesize

Set or show the size of the average of samples.

This command specifies the number of internal samples to average before generating an output. When combined with the `samplerate` command, it affects the output data rate. For simplicity, it is better to use the `outputrate` command in the basic menu.

- **Example:** `averagesize 8`
- **Reply:** None. Sets average number to 8.

digitalgain

Get or set the digital gain. Digital, or software, gain is set by the calibration command.

Caution: Changing `digitalgain` can affect the stability of your output data.

- **Example:** `digitalgain 3`
- **Reply:** None. Sets digital gain to 3.00.

distance

Set or show the distance between transducers. This is one of the settings that is changed during a calibration. We do not recommend altering this setting. If you enter a value as a single number, it will be applied to all four distances. If you enter four values, they will be applied respectively to the four distance values. The designed mechanical distance between transducers of a LI-550 is 0.03486 meters. See *User calibration* on page 8-1 for more information.

- **Example:** `distance`
- **Reply:** Distances for four paths.

The offset is also set during factory calibration. All four should be close to zero. Similar to distance, if you enter one number, it is applied to all four paths. If you enter four numbers, they will be applied separately to each path.

factoryrestore

Returns the instrument to the factory default settings. Enter `factoryrestore YES` and press return to apply the changes immediately.

humiditycalibrate

Gets or sets the slope and offset humidity calibration factors. This command allows you to add your own slope and offset values to the humidity sensor output. Note that the humidity is transferred through the Gore-Tex® vent on the bottom of the LI-550 and can take several minutes to equalize with there is a rapid change in humidity. Using the command without parameters returns the current slope and offset values. Providing the slope and offset parameter values sets these values for the humidity sensor.

- **Example:** `humiditycalibrate`
- **Reply:** Humidity Calibration: Slope = 1.000000, Offset = 0.000000
- **Example:** `humiditycalibrate slope 1.0`
- **Reply:** None; sets humidity calibration slope to 1.0.

lowpower

Sets or shows the low power parameters.

Command	Description
lowpower	Returns the current lowpower status and internal trigger setting.
enable	Enables low power mode
disable	Returns to normal mode
wakerate mSec	Sets the internal wake up rate using an internal RC timer, which is not highly accurate (firmware v2.5 and newer: $1 \leq \text{Sec} < 131,071$; firmware v2.4 and older: $200 \leq \text{mSec} < 32768$).
extwake enable	Use the trigger to signal a wake from low power mode
extwake disable	Disable the trigger signal as a wake up signal

- **Example:** `lowpower`
- **Reply:** Low power status and internal trigger setting.

offset

Set or show the offset values for all paths. These are calibration factors set during the calibration cycle. If you enter the value as a single number, it will be applied to all four distances. If you enter four values, they will be applied respectively to the four distance values. The offset value compensates for variations in manufacturing.

orientuv

Set or view the UV wind vector output coordinate system. Options are **std**, **ati**, **otsm**.

Note: There are different possible definitions for the meanings of the U and V axes. The **std** setting defines positive U as being from the west, and positive V as being from the south. This is the default output coordinate system. The **ati** setting defines the positive U as being from the north, and positive V as being from the west. The **otsm** setting matches the original TriSonica Mini output definition of positive U as being from the north, and positive V as being from the east.

paramdelim

Gets or sets the parameter delimiter for all display parameters. The measurement delimiter is a single character displayed immediately after the parameter value is displayed. This value is controlled by the `paramdelim` command. The default delimiter is a space character.

pressurecalibrate

Gets or sets the slope and offset pressure calibration factors. This command allows the Users to add their own slope and offset values to the pressure sensor output. Note that the pressure is transferred through the Gore-Tex® vent on the bottom of the TSM and can take several seconds to equalize when there is a rapid change in pressure. Using the command without parameters returns the current slope and offset values. Providing the slope and offset parameter values sets these values for the pressure sensor.

- **Example:** `pressurecalibrate`
- **Reply:** Pressure Calibration: Slope = 1.000000, Offset = 0.000000
- **Example:** `pressurecalibrate slope 1.0`
- **Reply:** None; sets pressure calibration slope to 1.0.

protocol

Show or set the current serial protocol setting. The command only works for the LI-550P, where the EIA422 signals are brought out to the connector. This is the software command to select between EIA232 and EIA422 modes. The `now` parameter makes the change immediately, otherwise the change happens after a system reset. LI-550P and TSM-PM only.

samplerate

Set or get the internal sample frequency. This command changes the internal sampling rate. When combined with the `averagesize` command, affects the output data rate. For simplicity, it is better to use the `outputrate` command in the basic menu.

shadowcorrect

Enable or disable the shadow correction calculations of the LI-550P and LI-550F. `1` = enable, `0` = disable. We recommend that you keep the correction enabled. It is enabled by default.

tagdelim

Gets or sets the tag delimiter for all display parameters. The tag delimiter is a single character displayed immediately after the parameter tag and is controlled by the

`tagdelim` command. The default delimiter is a space character.

tagid

Set the tag id to `id` in the specified parameter `param`. The new `id` for the display value of the `parameter`. The `id` can be a maximum of 8 characters.

triggertype

Get or set the trigger parameters (LI-550P only). Triggering can be internal or external and can be adjusted to trigger on the rising or falling edge of the external signal. Use the `triggertype` command and the parameters `posedge` and `negedge` to make this selection. The three trigger modes are available.

Trigger	Description
Internal Trigger	The LI-550P uses its own internal timer for sample triggering and runs asynchronous to other instruments. The LI-550F has only internal triggering.
External Trigger	When an external trigger is received, the LI-550P takes the number of samples specified in the <code>averagesize</code> command at the configured <code>samplerate</code> . When this sampling is complete, the output is generated and transferred over the serial port. The LI-550P then waits until the next trigger before sampling again. If the trigger is too fast to complete all the samples, the LI-550P will shorten the number of samples taken to maintain the external trigger rate.
Sync	The sync trigger mode adjusts the internal trigger sampling to align with the sync trigger, otherwise the LI-550P operates on its internal trigger. For instance, this is useful for aligning samples to a GPS pulse-per-second clock so multiple instruments can trigger simultaneously without being connected to the same trigger. Sync pulses can have a very long time between pulses.

Application programming interface

The LI-550 provides an Application Programming Interface (API), which is a method to simplify computer command automation. It is a variation on the command-line interface and uses the same commands as the command-line interface. The API commands are sent to the LI-550 during sampling mode. The command is enclosed in curly braces { and } without a carriage return or line feed character. One command per set of curly braces is allowed. The open curly brace { instructs the LI-550 that a API command is starting, and the close curly brace } indicates the end of the command. When the close curly brace } is received, the command is executed and the results returned within the curly braces.

Note: This is not compatible with the JSON protocol.

Section 7.

Troubleshooting

The sensor seems unresponsive

The LI-550 is designed to be unobtrusive. It operates quietly and lacks visible external LEDs. Follow these steps to determine if the device is working.

- **Can you hear the transducers?**

In a quiet room, hold the LI-550 close to your ear and listen for a faint clicking sound. Absence of sound alone is not an indicator of an issue because differences in auditory sensitivity and background noise may make the sound difficult to hear for some people. However, if you hear the clicking sound, the anemometer is working correctly. If you *do not* hear a sound, continue with the next steps.

- **Is the power supply working and wired correctly?**

Use a volt meter to measure power at the source and at any connections. The LI-550 requires 5 - 32 VDC (12 volts is ideal). Be sure the power supply wires are not shorted, and be sure that terminals are clamped onto wire rather than the insulation. See *Connecting the power and data cable* on page 3-1.

- **If using the USB adapter, is the USB port providing power?**

Remove the cover on the USB adapter. If it is plugged in to a powered USB port, two LEDs on the board will be illuminated, indicating power in and power out. (If desired, use a volt meter to measure voltage at the terminal connection. The USB adapter should be receiving around 5 volts from the power supply and delivering around 12 (± 0.75) volts to the anemometer.) Be sure that terminals are clamped onto wire rather than the insulation.

- **Are the RX and TX data wires connected correctly?**
Be sure that there are no shorted contacts and that the data connections are correct. Be sure that terminals are clamped onto wire rather than the insulation. See *Connecting the power and data cable* on page 3-1.
- **Correct COM port assigned to the USB adapter?**
To find the serial port number, open the Device Manager (press the Windows key , type **Device Manager**, then press **Enter**). Click **Ports (COM & LPT)**. Look for **USB Serial Port (COM#)**. Your serial port number is indicated by the number. The COM port must be the same as the one selected in the TriSonica GUI application.

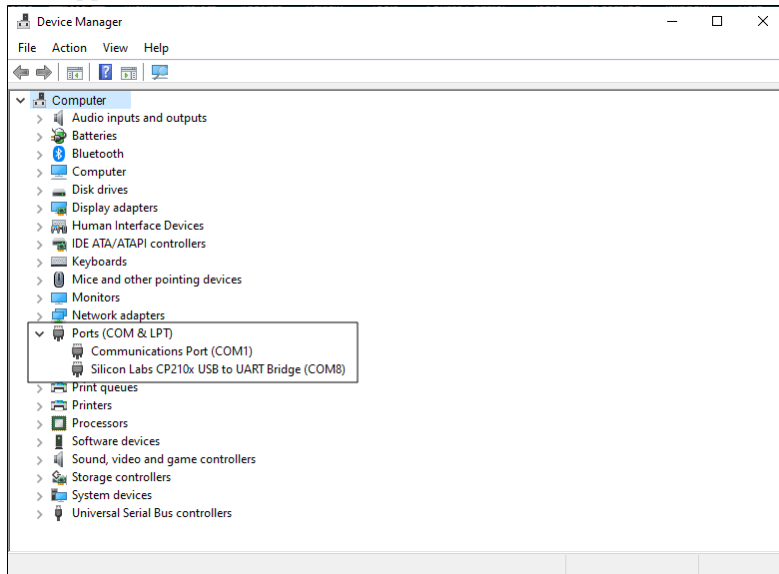

- **Data visible in a terminal program?**
The presence of data indicates that the anemometer is working properly. See *Serial communication settings* on page 4-1 for details.

Connection issues, no serial data, or the connection fails

If you are unable to connect to the device or view data:

- **Are the RX and TX data wires connected correctly?**

Be sure that there are no shorted contacts and that the data connections are not swapped. Be sure that terminals are clamped onto wire rather than the insulation. See *Connecting the power and data cable* on page 3-1.

- **Correct device drivers?**

Sometimes the Windows Operating System does not have the necessary device driver. To check, open your **Device Manager** (press the Windows key , type **Device Manager**, then press Enter).

- If you see **Silicon Labs CP210x USB to UART Bridge Controller** under **Ports (COM & LPT)**, your driver is current.
- If you see **CP2102N USB to UART Bridge Controller** under **Other devices**, your computer needs the updated driver.

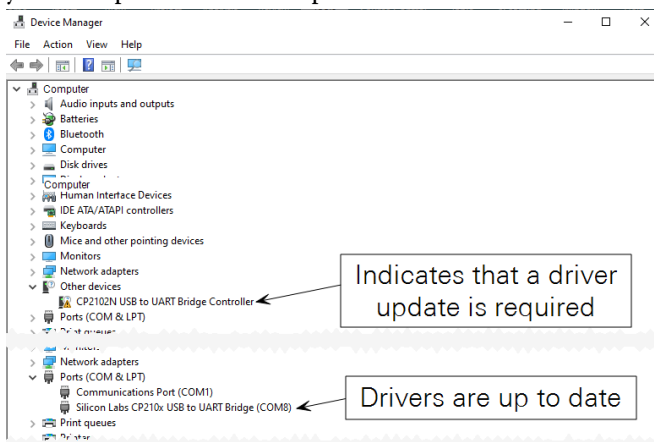

To update the driver:

- Go to silabs.com/developers/usb-to-uart-bridge-vcv-drivers and download the file called **CP210x Universal Windows Driver**.
- Extract files from the compressed folder; save them to your downloads folder.
- From the **Device Manager**, right click **CP2102N USB to UART Bridge Controller**, select **Update Driver**, and then select **Browse my computer for drivers**.

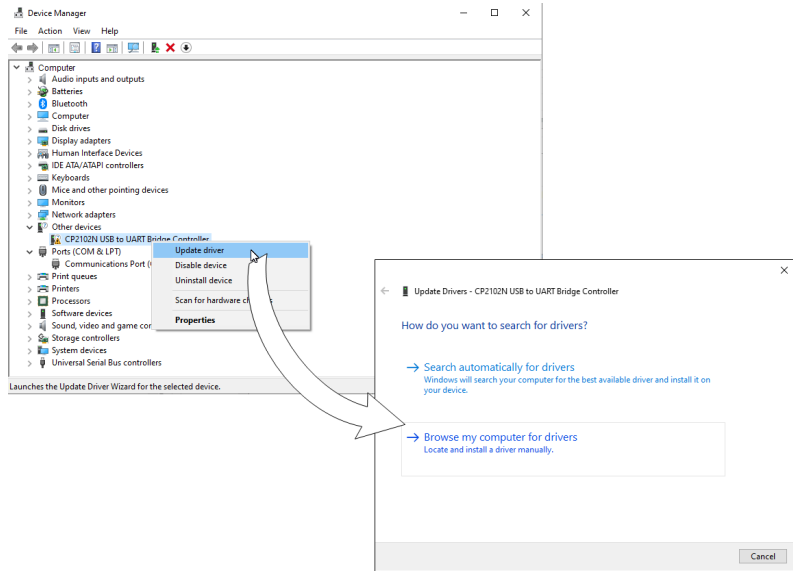

D Select the folder that has the extracted driver files and click through the prompts.

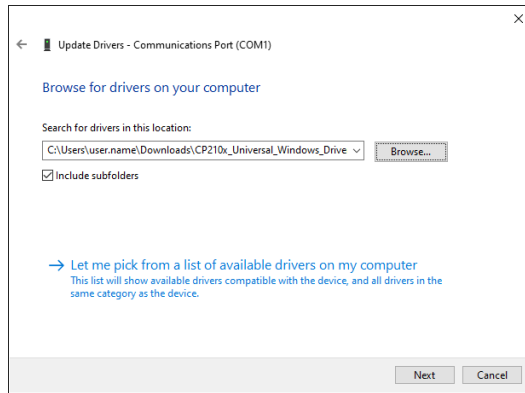

Your computer will install drivers and the USB adapter will be moved to the list of **Ports (COM & LPT)**, and be assigned a COM port number. Now you should be able to connect using the assigned COM port number.

If you've followed these steps and you are unable to connect, contact us at envsupport@licor.com for assistance.

Unexpected readings or errors

Unexpected readings and errors may indicate a wiring or configuration issue.

- **Unexpected offsets in compass or tilt readings?**

Check the calibration of the magnetic compass and digital level. If multiple anemometers are used together, calibrate them together to achieve consistency between them. See *User calibration* on page 8-1 for details on these procedures.

- **Temperature data noticeably different from expected?**

If the LI-550 sensor has been dropped or knocked about, or has become skewed during installation, the distance between transducers may have changed slightly from what was calibrated at the factory. Re-calibrate your sensor to the new distances by following the instructions in *User calibration* on page 8-1.

- **Blocked sonic path (values of -99.xx in the data stream)?**

If one or more paths between transducers is blocked, the anemometer will report an error message. Ice, snow, or some other physical material is preventing the ultrasonic signal reception. Clearing the blockage returns the unit to normal operation. Use the `diagnostic` command to get information about the error (see *Diagnostic* on page 5-4 for more details).

- **Calibration returning unreasonable values?**

If the values of wind speed or temperature are very different from the values entered into the calibrate command, it is possible that the current distance and offset values are outside the allowable range for the calibration algorithm. Enter **expert mode** and set the distance of all paths to 0.03486 with the command `distance 0.03486` and the offset to zero with `offset 0`. Then try the calibrate command.

- **Correct serial port settings?**

Check the baud rate and parity settings on the receiving unit or computer. The LI-550 default transmission settings are Baud Rate: 115,200, Data Bits: 8, Parity: None, Stop Bits: 1. In Tera Term, the serial connection settings are configured

under Setup > Serial port.

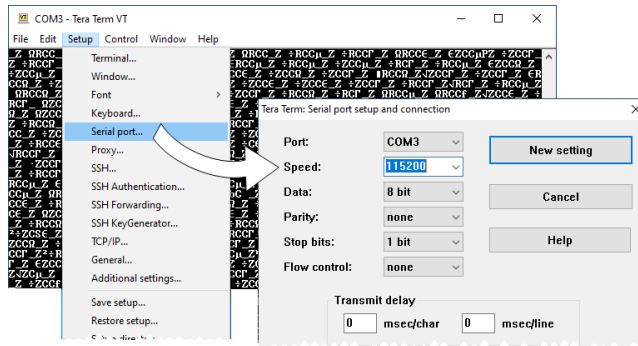

- **Is the power supply working and wired correctly?**
If the data still do not make sense or are all 99s, check the power supply and receiving unit (e.g., data logger) to make sure there is a ground connection between the power supply, the serial port receiving data, and the LI-550.
- **Power supply transient or variation?**
On rare occasions, a large deviation in the power supply voltage can lead to unexpected performance. Restart the device to resolve the issue.

If you've followed these steps and you are still observing errors, contact us at envsupport@licor.com for assistance.

Section 8.

Calibration and maintenance

The LI-550 requires very little maintenance. The sensor can be user-calibrated, as described below. The firmware can be updated as well.

User calibration

Every LI-550 is tested and calibrated prior to shipping. You can re-calibrate the sensor to acclimate to unique use cases or local conditions by following these directions.

Anemometer calibration

Place the LI-550 inside a small container to reduce the airflow to as close to zero as possible. Take care to eliminate acoustic reflections from hard sides and to not block the acoustic pathways. There should be some sound absorbing material on any flat walls that could reflect sound back towards the LI-550. A small box with acoustic absorption foam is ideal. However, in a pinch you can successfully calibrate a LI-550 by loosely wrapping a coat or towel around it. The main thing is to *provide a zero-wind environment*, and to know the temperature, and ideally the humidity, of the air volume where the LI-550 is enclosed.

Type `calibrate <temp> [<rh>]` where the `<temp>` = xx.x °C temperature and `<rh>` = xx.x% relative humidity (optional). If humidity is not supplied, then 50% is assumed.

- **Example:** Sending `calibrate 32 25` will adjust the temperature measurement to read 32 °C and the relative humidity measurement to read 25%.
- **Example:** Send `calibrate 32` to adjust the temperature measurement to read 32 °C and adjust the relative humidity to an assumed value of 50%.

The calibration cycle takes ten seconds. You will see dots in the serial console indicating progress, and the prompt will return when the calibration is completed. Enter `nvwrite` to store the new calibration values in non-volatile memory.

Level calibration

The calibration function of the level is simply an offset adjustment for the accelerometer inside the LI-550. Place the LI-550 on a level surface such that the bottom surface of the LI-550 is parallel with the level surface (accommodate the wires by providing a channel or hole). While the LI-550 is level, execute the `level-calibrate` command. Enter `nvwrite` to store the values in non-volatile memory.

Compass calibration

The compass calibration acclimates the compass module in the LI-550 to the local magnetic field. Start the compass calibration by using the `compasscalibrate` command. The compass calibration is active for fifteen seconds after initiation. During this time, tilt and rotate the LI-550 into as many orientations as possible using a three-dimensional figure-eight pattern. Enter `nvwrite` to store the values in non-volatile memory.

Recovering from a bad calibration

If, after calibrating temperature and relative humidity, the readings are not correct, reset the instrument to factory defaults in **Expert** mode, then try to calibrate again. Be sure to exit expert mode before storing the new calibration to non-volatile memory using `nvwrite`.

Firmware updates

Firmware updates will include bug fixes and feature improvements. Any LI-550 TriSonica Mini can be updated to the latest firmware except devices running firmware 1.2 and older.

Updating firmware

You can download the latest firmware release at licor.com/env/support/LI-550/software.html. Save the program to your computer. Connect the LI-550 to that computer. From this point, choose a method of to load the update:

Using the TriSonica application:

1 In the Settings Tab click Browse....

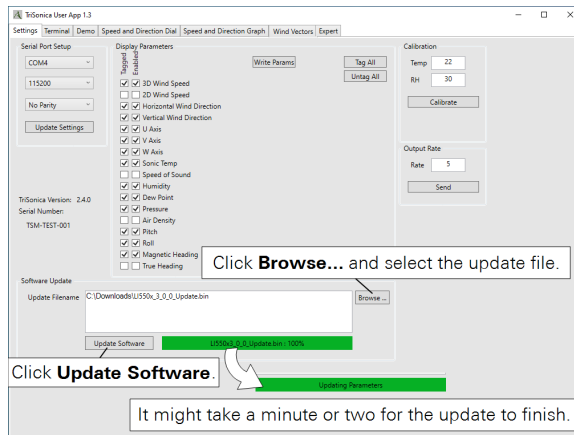

2 Navigate to the downloaded file and select it.

3 Click Update Software.

The LI-550 will copy the new files and the new version number will be displayed.

4 Perform a user calibration (see *User calibration* on page 8-1).

Using Tera Term (Terminal Emulator):

1 With the LI-550 connected to the terminal program, press CTRL+C.

2 Type `programupdate YES`.

3 From the Tera Term menu, select the following: File > Transfer > YModem > Send.

- 4 Select the file to upload and press **Enter**.
- 5 Perform a user calibration (see *User calibration* on page 8-1).

Updating the bootloader

Two programs reside in the internal memory of the LI-550: the LI-550 application and a bootloader. During a reset or power on, the bootloader checks to determine if the LI-550 application is valid. If the sensor application is valid, the bootloader turns over control to the sensor application. If the sensor application is not valid, the bootloader shows a command line interface with a limited set of commands: `help`, `programupdate`, `systemreset`, and `factoryreset`. These commands perform the same functions described in *Configuring with the command-line interface* on page 6-1.

Follow these steps if you need to update the **Bootloader**:

- 1 Update the LI-550 application.
- 2 Enter the command line interface.
- 3 Enter the expert mode with the command `expert enable`.
- 4 Enter the command `bootloadupdate YES` to update the bootloader.

Cleaning the sensor

Disconnect the LI-550 cable or wires from power, but be sure to keep the cable or wires attached to the LI-550 to keep water off of the terminals.

Rinse the outer surface of the sensor gently with water. Be careful to avoid spraying water at the vent on the base of the sensor.

If the exterior surface needs more cleaning, wipe the exterior surfaces with a soft lint-free cloth. The cloth may be either dry or wet with ordinary soap and water.

Section 9.

Specifications

Specifications are subject to change without notice.

Power Supply Voltage: 5 - 32 VDC¹

Power: 400 mW

Operating Environment:

Altitude: Up to 5000 meters

Temperature: -20 to 72 °C

Relative Humidity: 0 to 100% (non-condensing). System may require reset if condensation accumulates within enclosure.

The 550USB is not rated for outdoor use.

Transient Overvoltage: Category I

Temporary Overvoltage: 40 Volts

Pollution Tolerance: Level 3 (enclosure must be intact and humidity vent in good condition)

Sampling Frequency: 40 Hz maximum

Ultrasonic Frequency: 60 kHz \pm 5 kHz

Weight:

LI-550F: 50 grams

LI-550P: 67 grams

Size:

LI-550F: 91.9 \times 91.9 \times 53.6 mm

LI-550P: 80 \times 80 \times 73.3 mm

Digital Outputs:

LI-550F: RS-232

LI-550P: RS-232, RS-422, UART-3V

Output Rate: 1 Hz, 2 Hz, 5 Hz, 10 Hz, 20 Hz, or 40 Hz

¹This rating applies to units with S/N M00841 and later. Earlier TSM Sensors required 9 - 32 VDC.

Wind Speed Measurements:

Range: 0-50 m/s

Resolution: 0.01 m/s

Accuracy (0-10 m/s): ± 0.2 m/s

Accuracy (11-30 m/s): $\pm 2\%$

Accuracy (31-50 m/s): $\pm 4\%$

Wind Direction Measurements:

Resolution (u/v/w): 1.0°

Range (u/v): 0 to 359°

Accuracy (u/v): $\pm 1.0^\circ$

Range (w): $\pm 15^\circ$ from the horizontal plane of the instrument

Accuracy (w): 0.2 m/s

Humidity Sensor:

Range: 0 to 100% RH

Resolution: 0.01%

Accuracy: $\pm 3\%$

Pressure Sensor:

Range: 50 to 115 kPa

Resolution: 0.01 kPa

Accuracy: ± 1.0 kPa

Temperature Measurements:

Range: -20°C to 72°C

Resolution: 0.01°C

Accuracy: $\pm 2.0^\circ\text{C}$

Magnetometer:

Range (u, v, w): ± 50 Gauss

Heading Accuracy: $\pm 5^\circ$

Accelerometer:

Range (u, v, w): ± 2 g

Tilt (pitch, roll): $\pm 90^\circ$

Appendix A.

Lists of tables and figures

Figures

Figure 1-1. The LI-550F (left) features a flat base and four bare wires. The LI-550P (right) mounts to a pipe and features a 12-pin connector.	1-1
Figure 2-1. The north indicator is an arrow and letter N on the sensor.	2-1
Figure 2-2. LI-550F dimensions.	2-2
Figure 2-3. The LI-550F can be mounted with the mounting adapter.	2-3
Figure 2-4. 550FM mounting adapter dimensions.	2-3
Figure 2-5. LI-550P dimensions.	2-4
Figure 2-6. The LI-550P can be mounted with the mounting adapter.	2-5
Figure 2-7. 550PM mounting adapter dimensions.	2-5
Figure 3-1. USB adapter with the top cover removed. Wire colors represent the LI-550F.	3-2
Figure 3-2. 12-socket connector and assignments on the LI-550P.	3-3
Figure 3-3. Separate the wire leads from the cable and connect to the USB adapter.	3-5
Figure 6-1. The display command retrieves the current configuration - showing parameters that are available, tag status, tag value, number of decimals, whether enabled, and the units.	6-4
Figure 6-2. The units menu displays variable names, descriptions, and the units that are currently in use.	6-7

Tables

Table 1-1. Cables available for the LI-550s and LI-560s.	1-3
Table 1-2. TriSonica family comparison guide.	1-4
Table 3-1. Wire assignments for the LI-550F.	3-1
Table 3-2. LI-550F-to-USB adapter wire colors and assignments.	3-2
Table 3-3. LI-550P socket descriptions and cable wire colors.	3-4
Table 3-4. LI-550P-to-USB adapter wire colors and assignments.	3-5
Table 4-1. Variables measured by the LI-550, as well as default tags and units. Tags are user-configurable and units are user-selectable.	4-5
Table 6-1. The help command.	6-2

Standard Terms and Conditions

1. General. LI-COR Inc. (“LI-COR”) is delivering these goods and products (“Products”) subject to these Terms and Conditions of Sale (“Conditions”). Buyer will be deemed to have assented to these Conditions upon Buyer’s placement of order. Notwithstanding the above, failure of LI-COR to object to provisions contained in any purchase order or other form or document from Buyer shall not be construed as a waiver of these Conditions nor an acceptance of any such provision.
2. Buyer’s Use Only/No Resale. The purchase of Products only conveys to Buyer the non-transferable right for only Buyer to use the quantity of Products and components of Products purchased in compliance with the applicable intended use statement, limited use statement or limited label license, if any, in LI-COR catalogues or on the label or other documentation accompanying the Products (all such statements or licenses being incorporated herein by reference as if set forth herein in their entirety). Buyer has no right to resell the Products, or any portion of them, and any such resale is strictly prohibited unless LI-COR first accepts and approves a purchase order and acknowledges in writing that the Products may be resold by Buyer and the terms of such resales.
3. Prices/Taxes. All prices are quoted for delivery to Buyer when goods are loaded on the carrier at LI-COR premises in Lincoln, Nebraska, USA. Accordingly, unless otherwise specified by LI-COR, prices are exclusive of shipping, insurance and installation charges, all of which are Buyer’s sole responsibility. All prices are exclusive of all sales, use, excise, value added, withholding and other taxes, and all customs, duties, documentation charges, and freights forwarder charges now or hereafter claimed or imposed by any governmental authority upon the sale of the Products. Any such charges will be added to the product invoice or subsequently invoiced to the Buyer. In the event LI-COR is required to pay any such tax, duty or charge, Buyer will promptly reimburse LI-COR.
4. Payment Terms. All payments shall be made in immediately available U.S. Dollars net thirty (30) days from the date of invoice for qualified accounts, without set-off, deduction or withholding of any kind, unless otherwise stated by LI-COR in writing and may be paid by check (drawn on a U.S. bank), wire transfer or major credit card. All open account invoicing must be pre-approved. Any amounts not paid when due will accrue interest at the rate of 1 1/2% per month, or the maximum amount allowed by law, if lower. In the event that any payment is more than thirty (30) days late, LI-COR shall have the right to suspend doing business with Buyer until all past due balances are made current. Buyer shall pay for all costs (including reasonable fees) incurred by LI-COR in connection with the collection of late payments. Each accepted purchase order is a separate, independent transaction, and Buyer has no right of set-off against other purchase orders or other transactions with LI-COR. Buyer hereby grants LI-COR a security interest in the Products in the amount of the unpaid balance of the purchase price until paid in full. LI-COR may file a financing statement for such security interest and Buyer shall sign any such statements or other documentation necessary to perfect LI-COR security interest.
5. Return Policy. Buyer may return non-consumable Products to LI-COR within forty-five (45) days of invoice date only with prior authorization by LI-COR, the Product(s) being returned in new and unused condition and must be resalable as new. Any returned Product(s) are subject to payment of a fifteen percent (15%) re-stocking fee on all items returned. Buyer shall be responsible to make payment to LI-COR for any and all expenses related to deinstallation of the Product(s), including but not limited to shipping, duties, and taxes. All payments subject to this provision shall be made to LI-COR within thirty (30) days of return, or de-installation, of the Product(s).
6. Delays In Performance. LI-COR shall not be liable for any delay in performance hereunder due to unforeseen circumstances or due to circumstances beyond its control including, but not limited to, acts of nature, acts of government, labor disputes, delays in transportation, delays in customs clearance and delays in delivery or inability to deliver by LI-COR’s suppliers.

7. Shipment and Packing. All Product prices exclude costs of shipping and handling and insurance, in accordance with delivery terms designated by LI-COR. Unless otherwise agreed in writing, such costs will be paid by the Buyer and will appear as a separate item on LI-COR invoice. LI-COR shall ship in accordance with LI-COR standard practices. Buyer may specify different shipping instructions, subject to agreement by LI-COR. Unless otherwise agreed to in writing by LI-COR, all products shall be packaged, if appropriate, for shipment and storage in accordance with standard commercial practices. All packing shall conform to carrier requirements.

8. Partial Shipments. Any Products delivered in partial shipments may be invoiced individually. Additional shipping and handling charges may apply.

9. Title/Risk of Loss. All domestic shipments are made FOB per Uniform Commercial Code. All international shipments are made per INCOTERMS 2000 designated by LI-COR. LI-COR title to the Products and the risk of loss of or damage to the Products ordered by the Buyer will pass to Buyer at time of LI-COR delivery of Products to the carrier. The carrier shall be deemed Buyer's agent, and any claims for damages in shipment must be filed with the carrier. LI-COR is authorized to designate a carrier pursuant to LI-COR standard shipping practices unless otherwise specified in writing by Buyer.

10. Intellectual Property Rights. Title to and ownership of the documentation, and any improved, updated, modified or additional parts thereof, and all copyright, patent, trade secret, trademark and other intellectual property rights embodied in the Products, shall at all times remain the property of LI-COR or LI-COR licensors.

11. Acceptance. All sales are final and all Products shall automatically be deemed accepted upon delivery to Buyer when goods are loaded on the carrier at LI-COR premises in Lincoln, Nebraska, USA. Buyer may not return any Products to LI-COR except as provided for by LI-COR warranty or as provided herein.

12. Product Warranties. Unless otherwise specified by LI-COR:

(a) LI-COR warrants that, for a period of twelve (12) months from the date of shipment of the Products from LI-COR (the "Warranty Period"), unless otherwise specified for individual Products or extended by a Support Contract or Extended Warranty Contract, the Products sold hereunder will be free from material defects in materials and workmanship and will conform to LI-COR published specifications in effect as of the date of manufacture. LI-COR SPECIFICALLY DISCLAIMS ANY INDIRECT, SPECIAL, INCIDENTAL OR CONSEQUENTIAL DAMAGES (INCLUDING LOSS OF USE OR LOST PROFITS) WHICH MAY RESULT FROM THE USE OF PRODUCTS PURCHASED HEREUNDER, AS FURTHER SET FORTH IN SECTION 13 OF THESE CONDITIONS OF SALE. This limited warranty extends only to Buyer as original purchaser unless otherwise agreed upon in writing by LI-COR.

(b) The foregoing warranty shall not apply if the defective Product (i) has been subjected to abuse, misuse, neglect, negligence, accident, improper testing, improper installation, improper storage, improper handling or use contrary to any instructions issued by LI-COR, (ii) has been repaired or altered by persons other than LI-COR, (iii) has not been installed, operated, repaired and maintained in accordance with the documentation or operated outside of the environmental specifications for the Product; (iv) has failed due an Act of God, including but not limited to fire, flood, tornado, earthquake, hurricane or lightning or (v) has been used with any devices, accessories or products not manufactured by or approved by LI-COR. In addition, the foregoing warranty shall not apply to Products (i) LI-COR Standard Terms and Conditions of Sale – rev. 5/15/2009 marked or identified as "sample," (ii) loaned or provided to Buyer at no cost, or (iii) which are sold "as is."

(c) If during the Warranty Period: (i) LI-COR is notified promptly in writing upon discovery of any defect in the Product, including a detailed description of such alleged defect, (ii) such Product is returned, transportation charges prepaid, to LI-COR designated manufacturing facility subject to the prior approval of LI-COR with a valid Return Material Authorization ("RMA") number, and (iii) LI-COR inspections and tests determine that the Product is indeed defective and the Product has not been subjected to any of the conditions set forth above, then, as Buyer's sole remedy and LI-COR sole obligation under the foregoing warranty, LI-COR will, at LI-COR option, repair or replace without charge the defective Product. In no event will the Buyer itself nor will the Buyer allow any party other than LI-COR or a third party authorized in writing by LI-COR to perform any service on the Products.

(d) During the Warranty Period, LI-COR will provide on-site warranty repair for Odyssey® Infrared Imager, Aerius Automated Infrared Imager, Pearl® Imager and/ or 4300 DNA Analyzer Products including travel costs, repair parts, and labor to maintain the hardware in proper operating condition. At LI-COR discretion, the Buyer may be required to run certain diagnostic procedures to help determine the source of the problem before on-site warranty repair is rendered. If an on-site service call is initiated, LI-COR will dispatch a service technician to the Buyer site. On-site service will be provided 8:00 a.m. to 5:00 p.m. (Buyer local time), Monday through Friday, excluding LI-COR holidays. The cost of a repair/service call for an instrument malfunction caused by third party hardware and/or software will be billed to Buyer on a time and material basis.

(e) Any Product that has either been repaired or replaced under this warranty shall have warranty coverage (parts only) for the longer of ninety (90) days or the remaining original warranty period. Replacement parts used in the repair of Products may be new or equivalent to new.

(f) EXCEPT FOR THE WARRANTIES SET FORTH IN THIS SECTION, LI-COR MAKES NO OTHER WARRANTIES, EXPRESS, IMPLIED OR STATUTORY, WITH RESPECT TO ANY PRODUCTS OR OTHER PRODUCTS PROVIDED IN CONNECTION WITH THESE CONDITIONS, INCLUDING WITHOUT LIMITATION ANY IMPLIED WARRANTY OF MERCHANTABILITY, FITNESS FOR A PARTICULAR PURPOSE, NONINFRINGEMENT, OR ARISING FROM COURSE OF PERFORMANCE, DEALING, USAGE OR TRADE.

(g) Notwithstanding anything herein to the contrary, LI-COR makes no warranty with respect to any third party products provided under these Conditions. Buyer's sole remedy with respect to such third party products shall be pursuant to the original manufacturer's or licensor's warranty, if any, to Buyer, to the extent permitted by the original manufacturer or licensor.

13. **Limitation of Liability.** IN NO EVENT SHALL LI-COR, ITS LICENSORS OR ITS SUPPLIERS BE LIABLE TO BUYER OR ANY THIRD PARTY FOR COSTS OF PROCUREMENT OF SUBSTITUTE PRODUCTS OR SERVICES, LOST PROFITS, DATA OR BUSINESS, OR FOR ANY INDIRECT, SPECIAL, INCIDENTAL, EXEMPLARY OR CONSEQUENTIAL DAMAGES OF ANY KIND ARISING OUT OF OR IN CONNECTION WITH THE USE OF THE PRODUCTS OR THESE CONDITIONS, HOWEVER CAUSED AND ON ANY THEORY OF LIABILITY (WHETHER IN CONTRACT, TORT (INCLUDING NEGLIGENCE), STRICT LIABILITY, PRODUCTS LIABILITY OR OTHERWISE). LI-COR TOTAL AND CUMULATIVE LIABILITY ARISING OUT OF OR IN CONNECTION WITH ANY PRODUCTS PURCHASED BY BUYER HEREUNDER SHALL IN NO EVENT EXCEED THE PURCHASE PRICE PAID BY BUYER FOR SUCH PRODUCTS. THE LIMITATIONS SET FORTH IN THIS SECTION SHALL APPLY EVEN IF LI-COR OR ITS SUPPLIERS HAVE BEEN ADVISED OF THE POSSIBILITY OF SUCH DAMAGES, AND NOTWITHSTANDING ANY FAILURE OF ESSENTIAL PURPOSE OF ANY LIMITED REMEDY.

14. **Authorized Use of Biotechnology Products.** Unless otherwise expressly indicated in LI-COR catalogues, LI-COR website or on the label or other documentation accompanying Biotechnology Products, the LI-COR Biotechnology Products are intended for RESEARCH USE ONLY and are not to be used for any other purposes including, but not limited to, unauthorized commercial purposes, in vitro diagnostic purposes, ex vivo or in vivo therapeutic purposes, investigational use, in foods, drugs, devices or cosmetics of any kind, or for consumption by or use in connection with or administration or application to humans or animals. Buyer acknowledges that the Biotechnology Products have not necessarily been tested for safety or efficacy, unless expressly stated in LI-COR catalogs or on the label or other documentation accompanying the Biotechnology Products.

15. **Authorized Use of Biotechnology Products.** Unless otherwise expressly indicated in LI-COR catalogues, LI-COR website or on the label or other documentation accompanying Biotechnology Products, the LI-COR Biotechnology Products are intended for RESEARCH USE ONLY and are not to be used for any other purposes including, but not limited to, unauthorized commercial purposes, in vitro diagnostic purposes, ex vivo or in vivo therapeutic purposes, investigational use, in foods, drugs, devices or cosmetics of any kind, or for consumption by or use in connection with or administration or application to humans or animals. Buyer acknowledges that the Biotechnology Products have not necessarily been tested for safety or efficacy, unless expressly stated in LI-COR catalogs or on the label or other documentation accompanying the Biotechnology Products.

16. **Severability.** If any portion of these Conditions is held invalid, the parties agree that such invalidity shall not affect the validity of the remaining portions of these Conditions.

17. **Export Control.** Buyer acknowledges and agrees that the Products purchased under these Conditions may be subject to restrictions and controls imposed by the United States Government and the regulations thereunder. BUYER WARRANTS THAT IT WILL NOT EXPORT OR RE-EXPORT ANY PRODUCTS PURCHASED WITHOUT PRIOR WRITTEN NOTIFICATION AND APPROVAL OF LI-COR.

18. **Assignment.** Buyer shall not assign or transfer these Conditions or any rights or obligations under these Conditions, whether voluntary or by operation of law, without the prior written consent of LI-COR. LI-COR may assign or transfer these Conditions to any successor by way of merger, acquisition or sale of all or substantially all of the assets relating to these Conditions. LI-COR or any successor may assign all or part of the right to payments under these Conditions. Any assignment or transfer of these Conditions made in contravention of the terms hereof shall be null and void. Subject to the foregoing, these Conditions shall be binding on and inure to the benefit of the parties' respective successors and permitted assigns.

19. **Entire Agreement.** These Conditions of Sale take precedence over Buyer's additional or different terms and conditions, to which notice of objection is hereby given. Acceptance by Buyer is limited to LI-COR Conditions of Sale. Neither LI-COR commencement of performance nor delivery shall be deemed or construed as acceptance of Buyer's additional or different terms and conditions. These Conditions supersede all prior communications, transactions, and understandings, whether oral or written, and constitute the sole and entire agreement between the parties

pertaining to the referenced quotation or purchase order, provided that: (1) these Conditions shall not, without LI-COR prior written consent, supersede any conflicting terms of: (a) prior written agreements duly executed by LI-COR, or (b) governmental purchase orders, terms of purchase, requests for quotation or acquisition regulations relative to governmental purchasers; and (2) to the extent not in conflict with any such prior or governmental terms, these Conditions shall supplement them. No modification, addition or deletion, or waiver of any of the terms and conditions of these Conditions shall be binding on either party unless made in a non-preprinted agreement clearly understood by both parties to be a modification or waiver, and signed by a duly authorized representative of each party.

20. Entire Agreement. These Conditions of Sale take precedence over Buyer's additional or different terms and conditions, to which notice of objection is hereby given. Acceptance by Buyer is limited to LI-COR Conditions of Sale. Neither LI-COR commencement of performance nor delivery shall be deemed or construed as acceptance of Buyer's additional or different terms and conditions. These Conditions supersede all prior communications, transactions, and understandings, whether oral or written, and constitute the sole and entire agreement between the parties pertaining to the referenced quotation or purchase order, provided that: (1) these Conditions shall not, without LI-COR prior written consent, supersede any conflicting terms of: (a) prior written agreements duly executed by LI-COR, or (b) governmental purchase orders, terms of purchase, requests for quotation or acquisition regulations relative to governmental purchasers; and (2) to the extent not in conflict with any such prior or governmental terms, these Conditions shall supplement them. No modification, addition or deletion, or waiver of any of the terms and conditions of these Conditions shall be binding on either party unless made in a non-preprinted agreement clearly understood by both parties to be a modification or waiver, and signed by a duly authorized representative of each party.

21. Force Majeure. Shipping dates are approximate and may be delayed absent prompt receipt from Buyer of all necessary information. LI-COR shall not be responsible for any failure to perform or delay attributable in whole or in part to any cause beyond its reasonable control, including but not limited to Acts of God, government actions, war, civil disturbance, insurrection, sabotage, labor shortages or disputes, failure or delay in delivery by LI-COR suppliers or subcontractors, transportation difficulties, customs clearance, shortage of energy, raw materials or equipment, or Buyer's fault or negligence. In the event of any such delay the date of delivery shall, at the request of LI-COR, be deferred for a period equal to the time lost by reason of the delay.

22. Governing Law and Venue. These Conditions and performance by the parties hereunder shall be construed in accordance with the laws of the State of Nebraska, U.S.A., without regard to provisions on the conflicts of laws.

Index

#

#

- 99.xx, 4-6, 7-5, 7-6
- 550FM, 1-2, 1-2, 2-3
- 550PM, 1-2, 2-5

A

- accelerometer, 2-6

B

- baud rate, 4-1
- bits, 4-1

C

- cables
 - data and power, 1-3
- calibration
 - compass, 8-2
 - level, 8-2
 - wind measurements, 8-1
- com port, 4-3
- command line interface, 4-4, 6-1
- compass, 2-6

D

- data cables, 1-3
- delimiters, 4-6
- dimensions, 2-2

- direction, 2-6

E

- error codes, 4-6

F

- firmware, 1-3, 8-3

I

- installation, 2-1

L

- level, 2-6

M

- measurements, 4-5
- menu interface, 4-4, 5-1
- mounting, 2-2

N

- north arrow, 2-1

O

- orientation, 2-6

P

- parameters, 4-5, 6-4, 6-7
- parity, 4-1

pin assignments, 3-1
power cables, 1-3

S

serial port number, 4-3
 finding, 7-2
socket assignments, 3-4
software, 1-3
stop bits, 4-1

T

tags, 4-5
Tera Term, 4-3
terminal, 4-3
tilt, 2-6

U

units, 4-5, 6-4, 6-7
updates, 8-3

V

variables, 4-5, 6-4, 6-7

W

wire colors, 3-1, 3-4

LI-COR Environmental

4647 Superior Street
Lincoln, Nebraska 68504
Phone: +1-402-467-3576
Toll free: 800-447-3576 (U.S. & Canada)
envsales@licor.com
envsupport@licor.com
licor.com/env

LI-COR GmbH, Germany

Siemensstraße 25A
61352 Bad Homburg
Germany
Phone: +49 (0) 6172 17 17 771
envsales-gmbh@licor.com
envsupport-eu@licor.com

LI-COR Ltd., United Kingdom

St. John's Innovation Centre
Cowley Road
Cambridge
CB4 0WS
United Kingdom
Phone: +44 (0) 1223 422102
envsales-UK@licor.com
envsupport-eu@licor.com

Beijing LI-COR Bioscience Ltd.

Room 502-503, 5th Floor, Jimen No.1 Office Building
Xitucheng Road, Haidian District
Beijing, China
Phone: +86-400-1131-511
china-sales@licor.com
china-support@licor.com

LI-COR Distributor Network

licor.com/env/distributors

984-20374 • 12/2023

LI-COR®